

SISTEMA DE FIXAÇÃO POR ALAVANCA

PDNNN

Suporte neutro para torneiar $62^{\circ}30'$ com pastilha negativa 55°

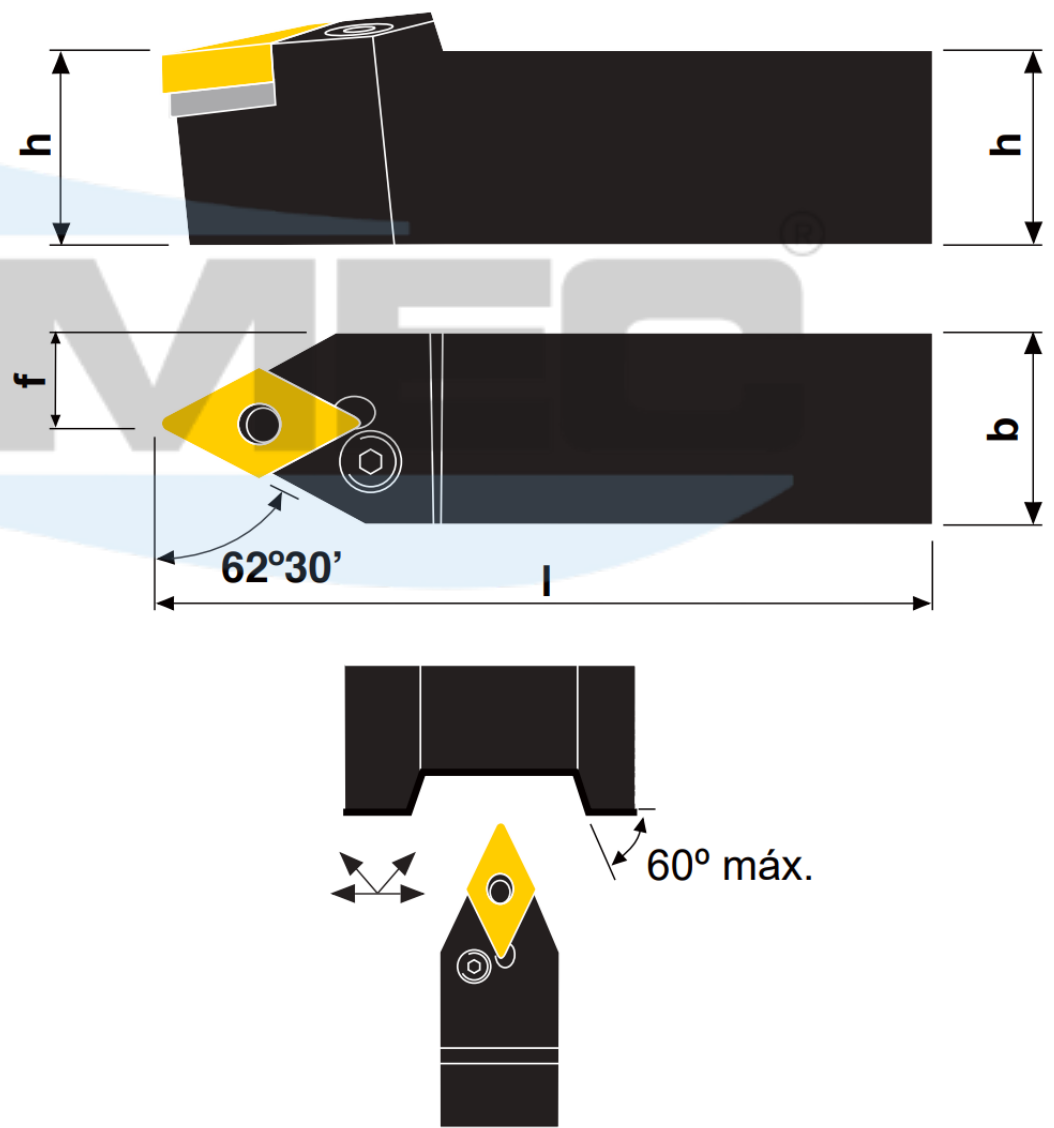

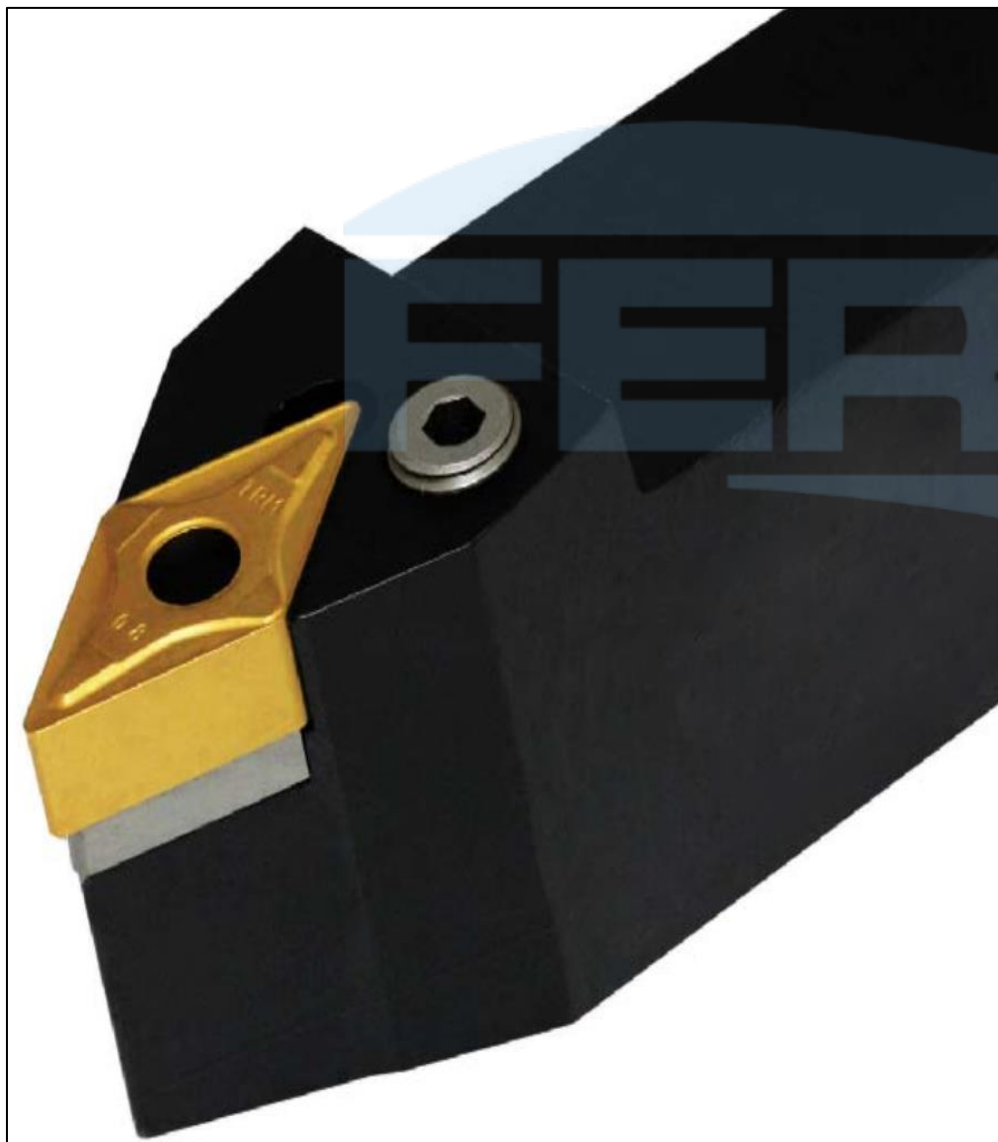
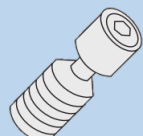

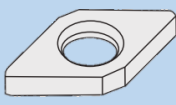
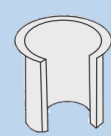
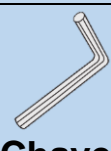
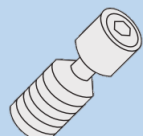
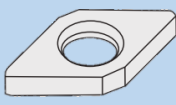
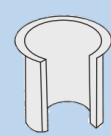
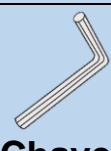

Ilustração na versão direita

Produtos	Dimensões (mm)				Pastilha	Acessórios				
	h	b	l	f		Alavanca	Parafuso	Calço	Rebite	Chave Allen
PDNNN 1616 H11	16	16	100	8,0	 DN_1104	 5432 001-01	 174.3-820M	 5322.255-01	 174.3-860	 C - 2,5
PDNNN 2020 K11	20	20	125	10						
PDNNN 2525 M11	25	25	150	12,5						
PDNNN 2020 K15	20	20	125	10	 DN_1506	 174.3-847M	 174.8-830	 171.35-850M	 174.3-861	 C - 3,0
PDNNN 2525 M15	25	25	150	12,5						
PDNNN 3232 P15	32	25	170	12,5						
PDNNN 4025 P15	40	25	170	12,5						