

# SISTEMA DE FIXAÇÃO POR ALAVANCA

## PRGNR

Suporte para torneiar e facear com pastilha negativa redonda

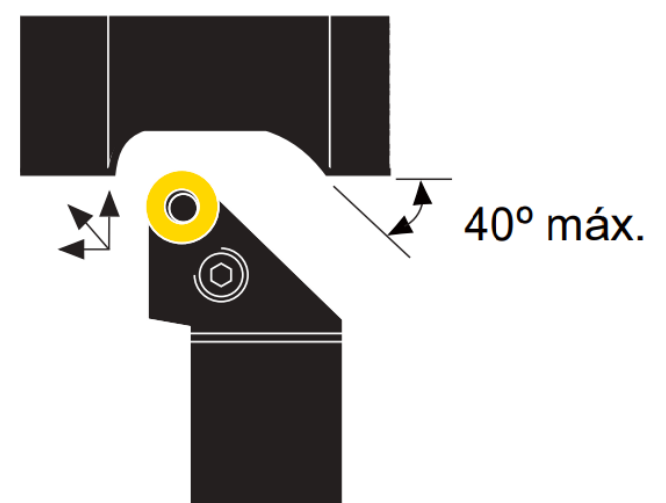

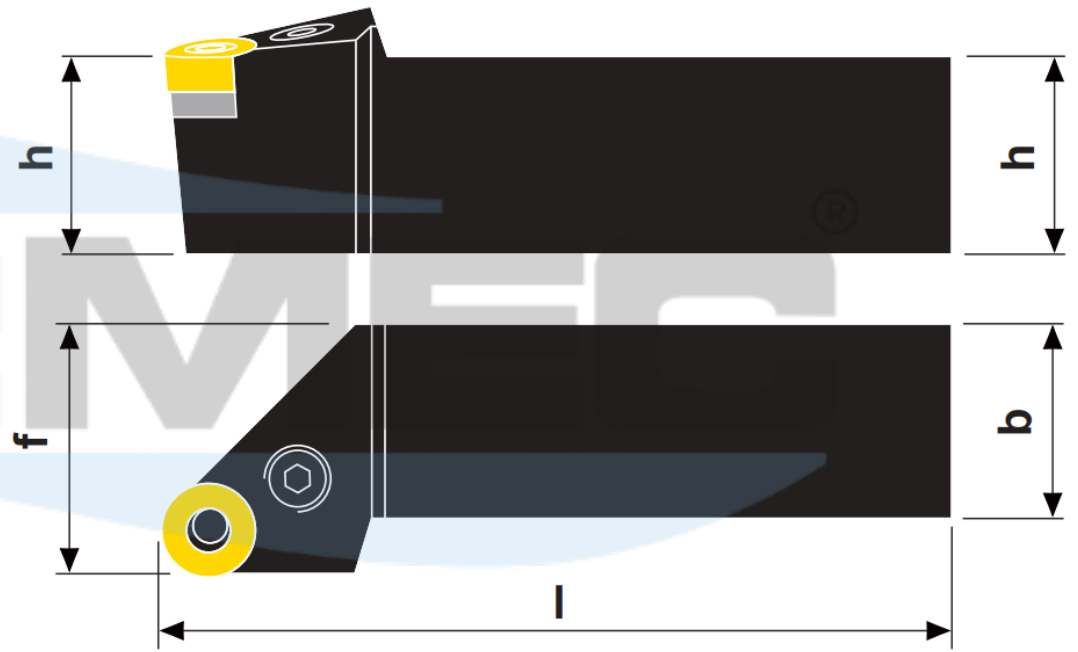

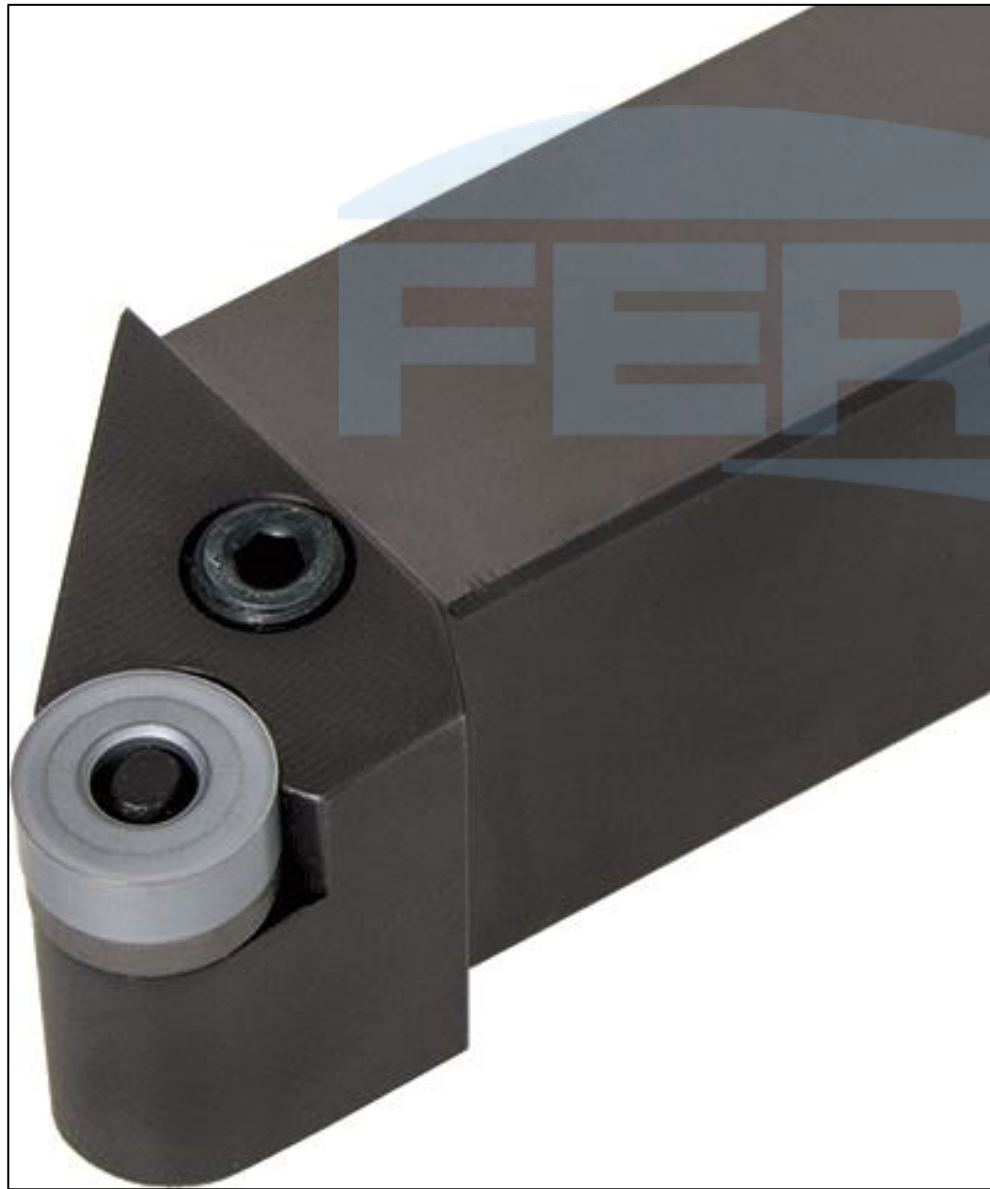
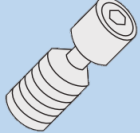
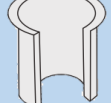

Ilustração na versão direita

Produtos	Dimensões (mm)				Pastilha	Acessórios				
	h	b	l	f			 Alavanca	 Parafuso	 Calço	 Rebite
PRGNR/L 2020 K12	20	20	125	25	RN_120400	174.3-841M	174.3-821	176.6-851M	174.3-861	C - 3,0
PRGNR/L 2525 M12	25	25	150	32						
PRGNR/L 3232 P15	32	32	170	40	RN_150600	174.3-843M	174.3-825	176.6-854M	174.3-864	C - 3,0
PRGNR/L 3232 P19	32	32	170	40	RN_190600	174.3-842M	174.3-822M	176.6-852M	174.3-862	C - 4,0
PRGNR/L 4040 S25	40	40	250	50	RN_250900	174.3-844M	174.3-827	176.6-853M	174.3-865	C - 5,0