

SISTEMA DE FIXAÇÃO DUPLO POR PINO E GRAMPO

MCDNN

Suporte neutro 40° com pastilha negativa 80° para aproveitamento do ângulo de 100°

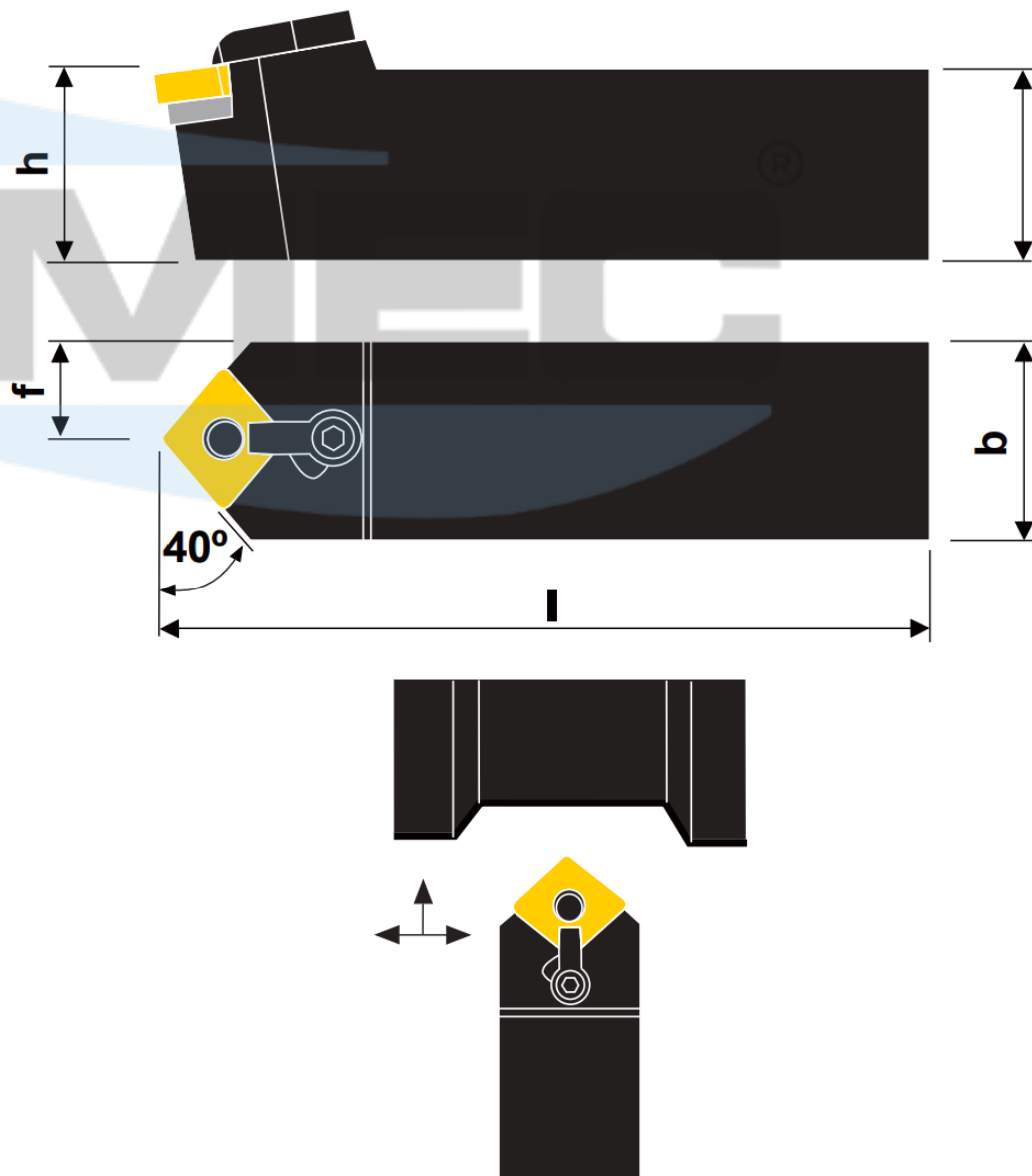

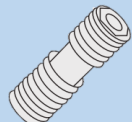
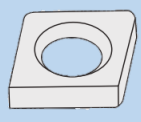
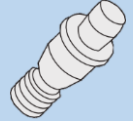
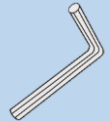

Ilustração na versão direita

Produtos	Dimensões (mm)				Pastilha	Acessórios				
	h	b	l	f		Grampo	Parafuso	Calço	Pino Paraf. do Calço	Chave Allen
MCDNN 2020 K12	20	20	125	10,3	 CN_1204 CNGN 1204 CNGN 1203	 NC-20 NC-23	 HT-1	 SCN-43 ICSN-433	 H308-1C H308-1CH	 C - 2,5 C - 1/8
MCDNN 2525 M12	25	25	150	12,8						
MCDNN 3225 P12	32	25	170	16,8						
MCDNN 4040 S19	40	40	250	21	CN_1906 CNGN1906	NC-9 NC-30	HT-2	SCN-64C	H312-1C H312-1CH	C - 4,0
MCDNN 5050 T19	50	50	300	26						