

SISTEMA DE FIXAÇÃO POR CUNHA-GRAMPO

MTENN

Suporte neutro 60° com pastilha negativa triangular









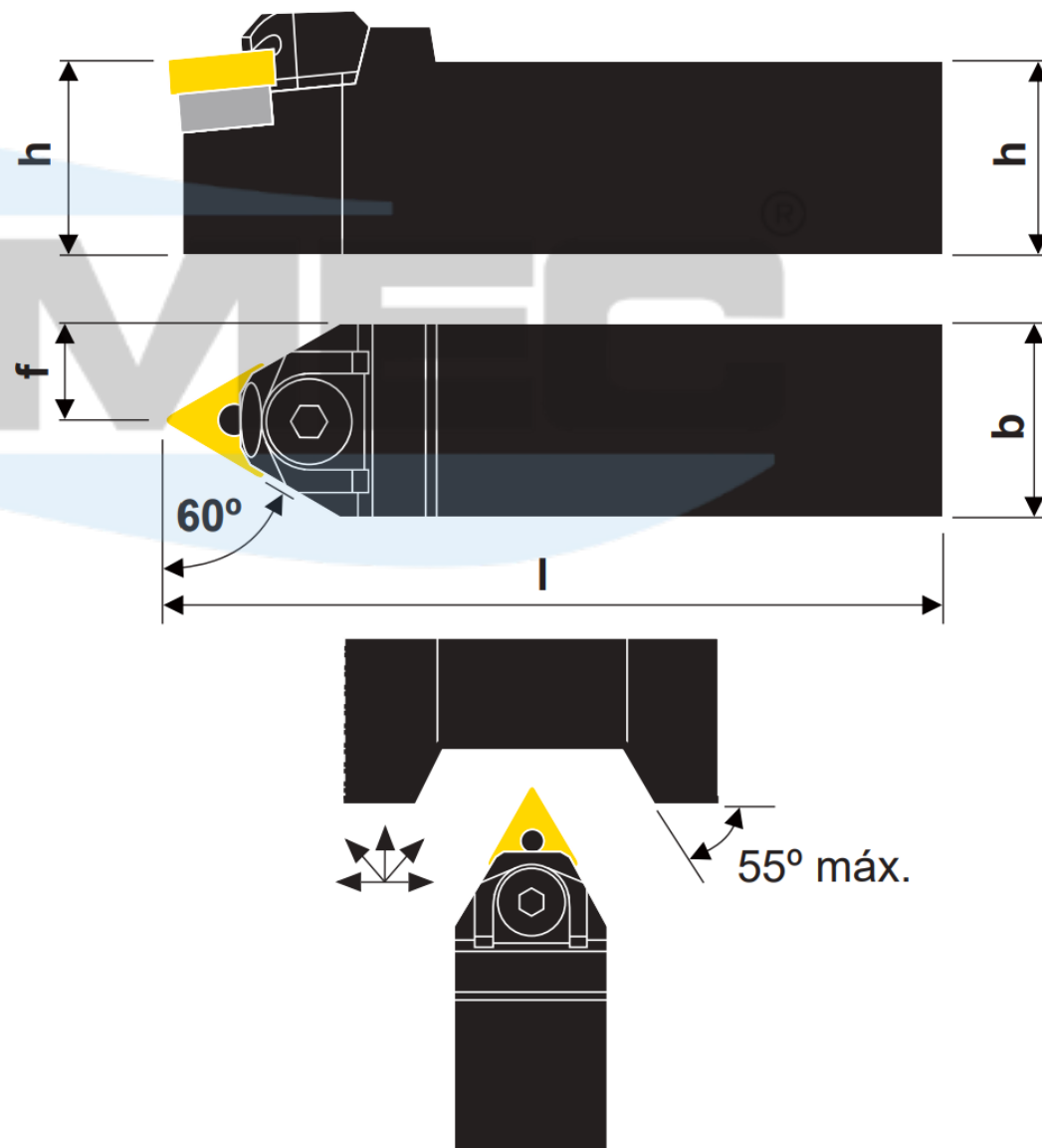
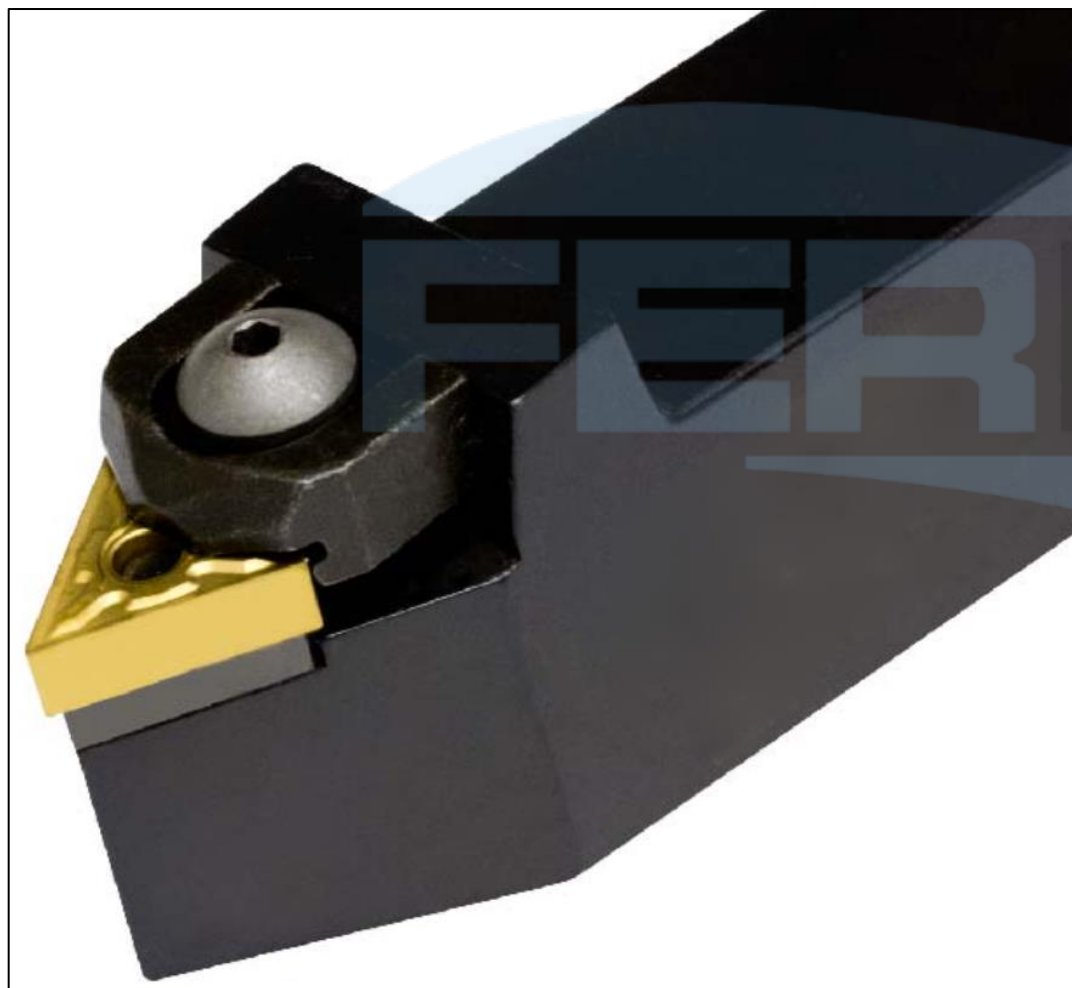

Ilustração na versão direita

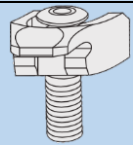
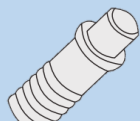
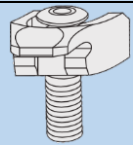
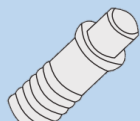
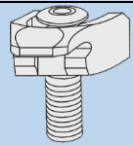
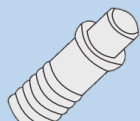
Produtos	Dimensões (mm)				Pastilha	Acessórios				
	h	b	l	f			 Cj. Grampo-Parafuso	 Parafuso do Pino	 Calço	 Pino
MTENN 2020 K16	20	20	125	10	TN_1604	 170.38-820-1	 3212 010-206	 170.3-852	 5312 021-02	C - 2,5
MTENN 2525 M16	25	25	150	12,5						
MTENN 3225 P16	32	25	170	12,5						
MTENN 2525 M22	25	25	150	12,5	TN_2204	 170.38-821-1	 3212 010-255	 170.3-855	 181.38-840	C- 3,0
MTENN 3225 P22	32	25	170	12,5						
MTENN 3232 P22	32	32	170	16						