

SISTEMA DE FIXAÇÃO POR PARAFUSO TORX TORX SVHBR

Suporte para torneiar e facear $107^{\circ}30'$ com pastilha positiva 35°

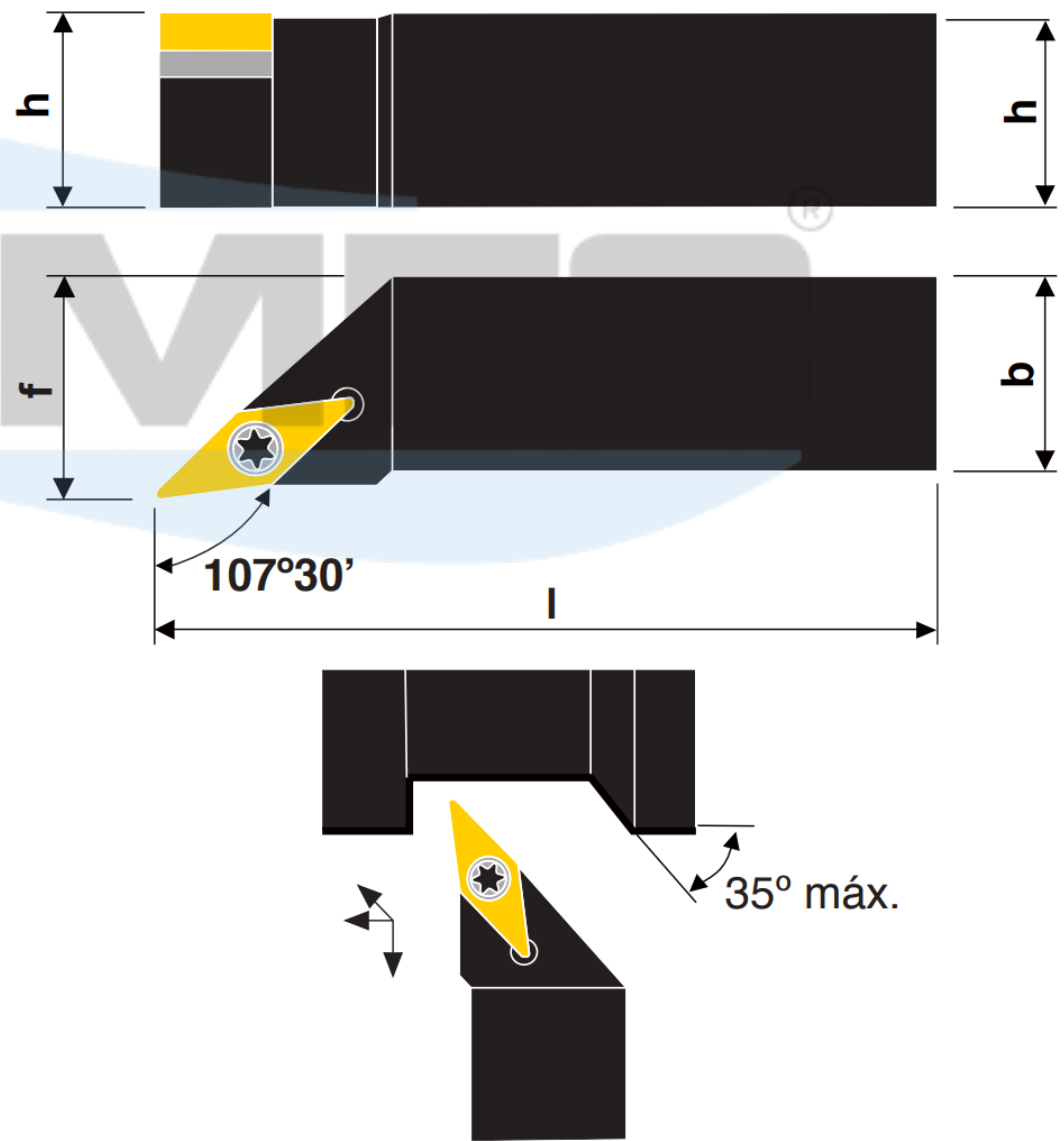

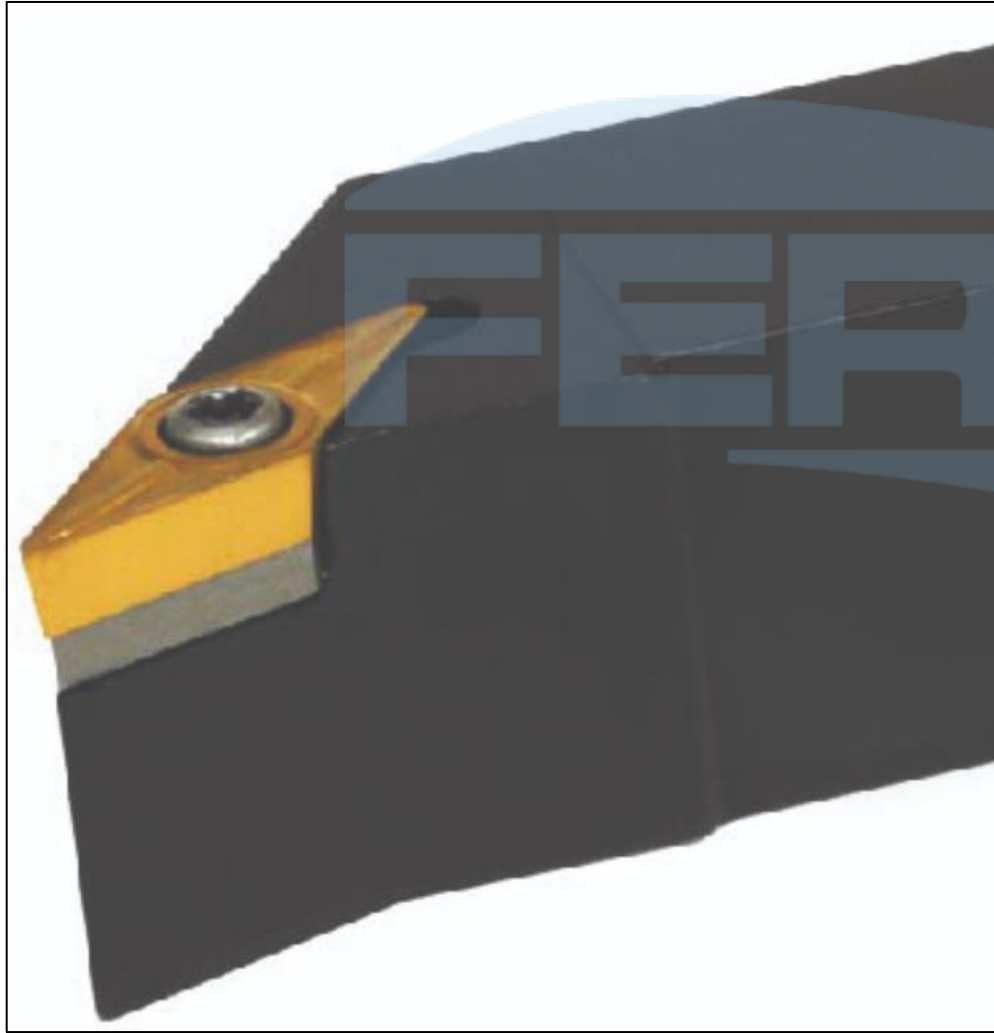
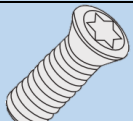

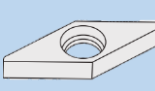
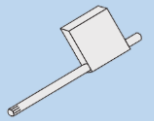

Ilustração na versão direita

Produtos	Dimensões (mm)				Pastilha 	Acessórios			
	h	b	l	f		 Parafuso Torx	 Calço	 Parafuso do Calço	 Chave Allen
SVHBR/L 2020 K16	20	20	125	25	VB_1604 VC_1604	5513 020-01	5322 270-01	5512 090-01	T15-B C - 9/64
SVHBR/L 2525 M16	25	25	150	32					
SVHBR/L 3225 P16	32	25	170	32					