

# SISTEMA DE FIXAÇÃO POR PARAFUSO TORX

## SVXCR

Suporte para torneiar e facear 112° com pastilha positiva 35°

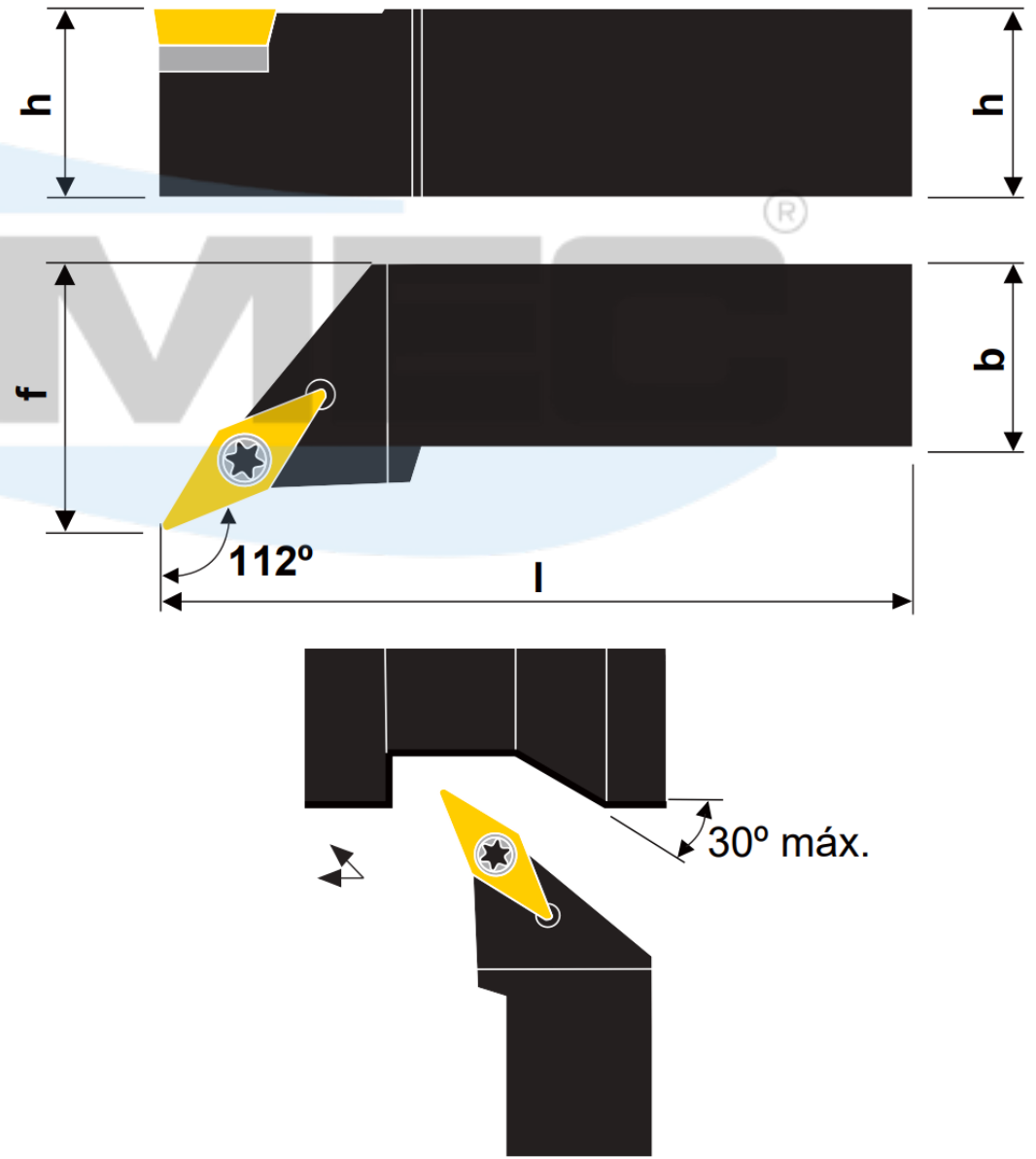

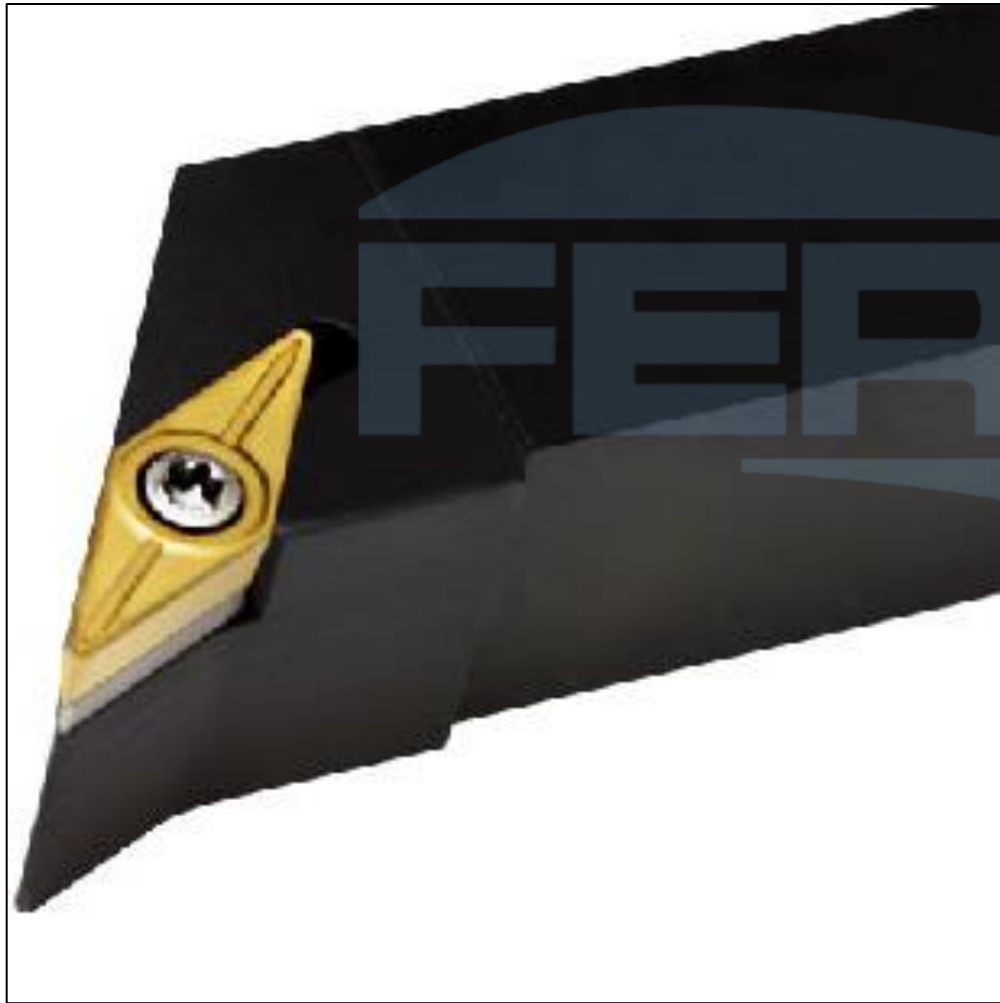
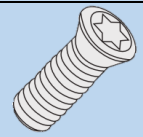
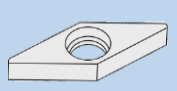
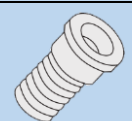
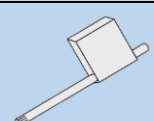

Ilustração na versão direita

Produtos	Dimensões (mm)				Pastilha 	Acessórios			
	h	b	l	f		 Parafuso Torx	 Calço	 Parafuso do Calço	 Chave Torx / Allen
SVXCR/L 2020 K16	20	20	125	25	VB_1604 VC_1604	5513 020-01	5322 270-01	5512 090-01	T15-B C - 9/64
SVXCR/L 2525 M16	25	25	150	32					