

SISTEMA DE FIXAÇÃO POR GRAMPO

CRDCR

Suporte para tornear e facear com pastilha positiva redonda

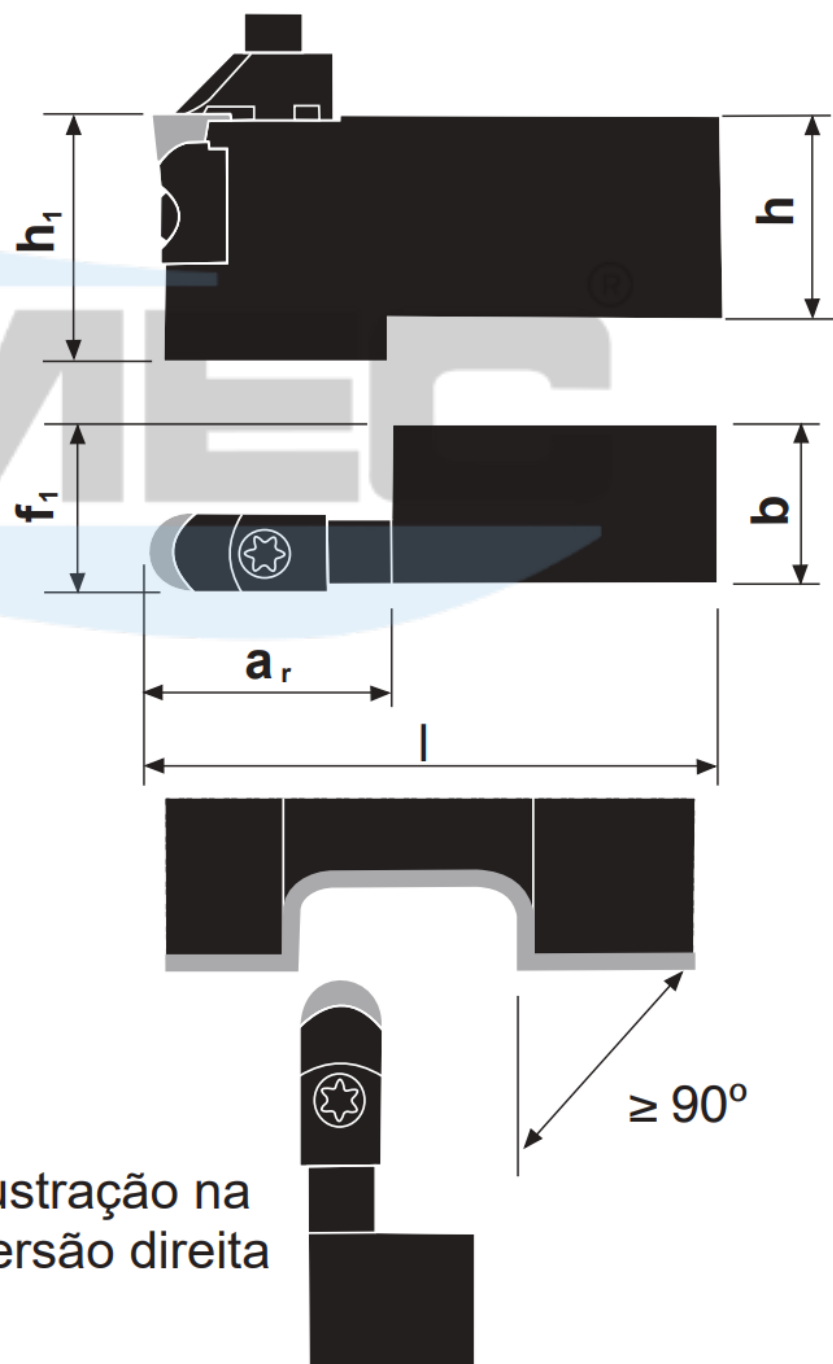

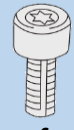

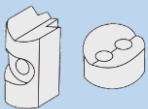
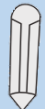
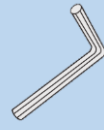

Ilustração na versão direita

Produtos	Dimensões (mm)						Pastilha	Acessórios					
	h	h1	b	l	f	ar		 Grampo	 Paraf. do grampo	 Calço	 Paraf. do Calço	 Rebite	 Chave Allen
CRDCR/L 2525 M06-A	25	30,1	25	150	25,6	19,4	RCGX 060600	5412 110-02	M6x20	5321 066-01	M2,5x10	-	C - 2 C - 5
CRDCR/L 3225 P09-A	32	32	25	170	25,8	29,5	RCGX 090700	5412 100-01	M5x12	5321 065-01	M3,5x12	-	C - 2,5 C - 4
CRDCR/L 3225 P12-A	32	32	25	170	25,9	38,5	RCGX 120700	5412 100-02	M6x20	5321 065-02	-	3113 030-355	C - 5