

SISTEMA DE FIXAÇÃO RÍGIDA

DTFNR

Suporte para facear 91° com pastilha negativa triangular











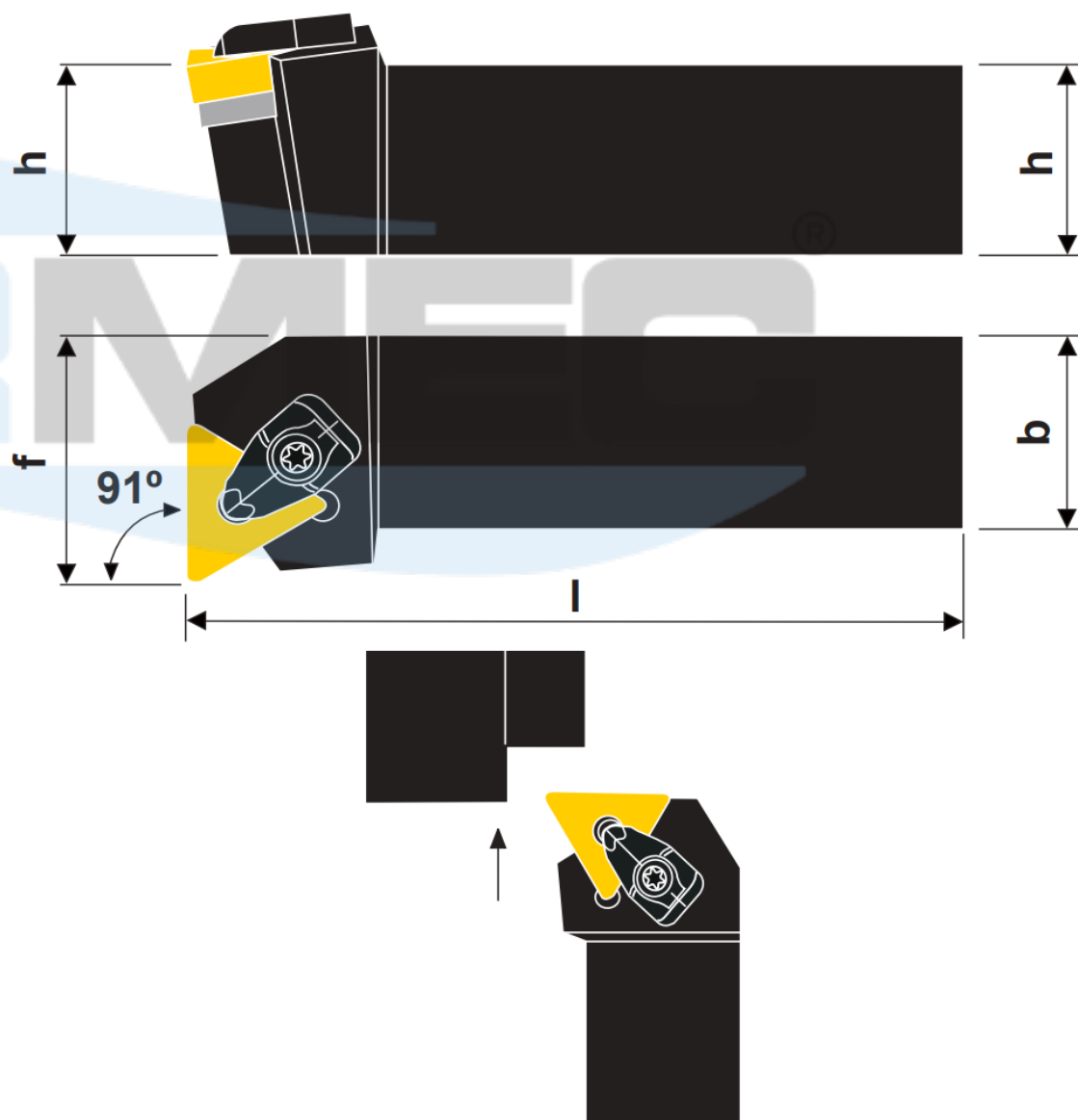
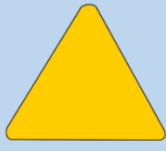











Ilustração na versão direita

Produtos	Dimensões (mm)				Pastilha	Acessórios						
	h	b	l	f								
DTFNR/L 2020 K16	20	20	125	25	TN_1604							
DTFNR/L 2525 M16	25	25	150	32								
DTFNR/L 3225 P16	32	25	170	32								
DTFNR/L 2525 M22	25	25	150	32	TN_2204							
DTFNR/L 3232 P22	32	32	170	40								