

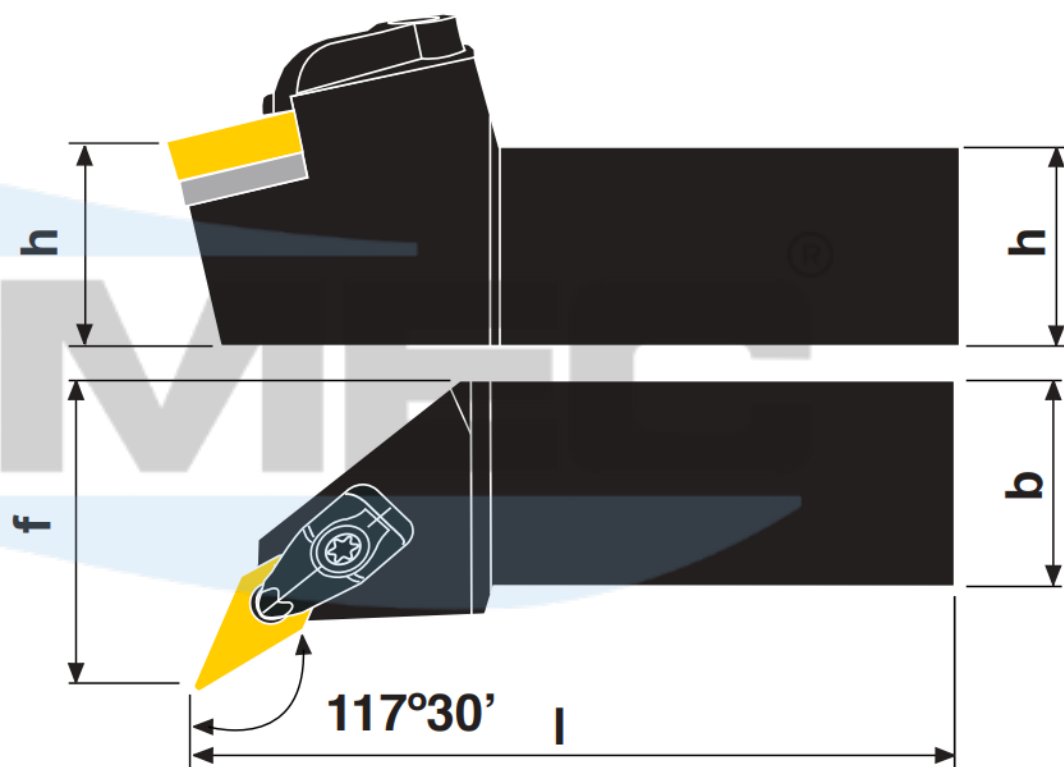







# SISTEMA DE FIXAÇÃO RÍGIDA

## DVPCR

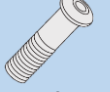
Suporte para tornear 117°30' com pastilha negativa 35°



Produtos	Dimensões (mm)				Pastilha 	Acessórios						
	h	b	l	f		 Grampo	 Paraf. do Grampo	 Calço	 Paraf. do Calço	 Pino	 Mola	 Chave Torx
DVPCR/L 2020 K16	20	20	125	25	VN_1604	5412 028-06	5412 086-02	5322 269-01	5513 020-09	5412 030-307	5412 001-58	T15-F
DVPCR/L 2525 M16	25	25	150	32								
DVPCR/L 3232 P16	32	32	170	40								
DVPCR/L 4040 S16	40	40	250	50								