

SISTEMA DE FIXAÇÃO POR ALAVANCA

PCBNR

Suporte para torneiar 75° com pastilha negativa 80° para aproveitamento do ângulo de 100°











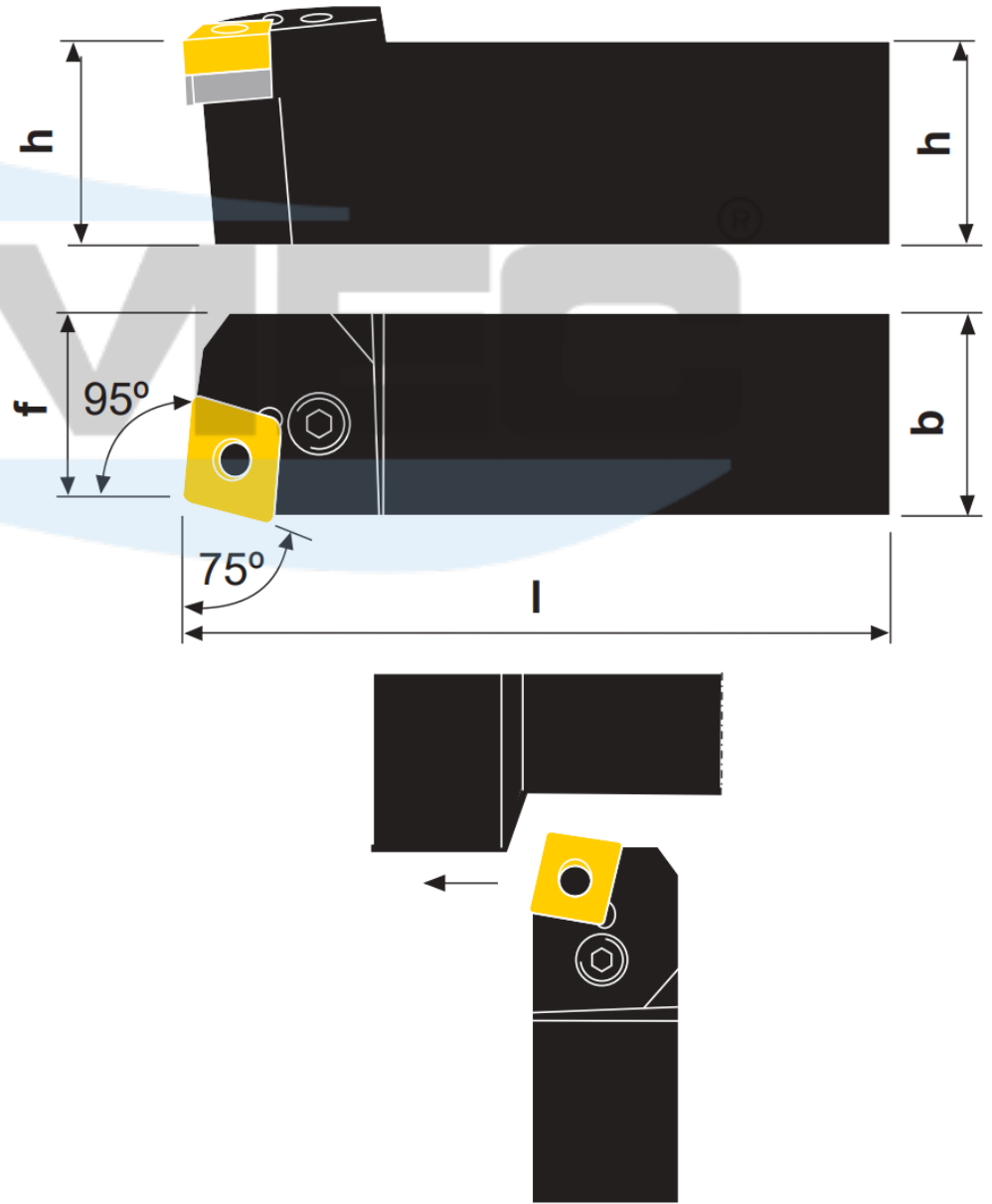
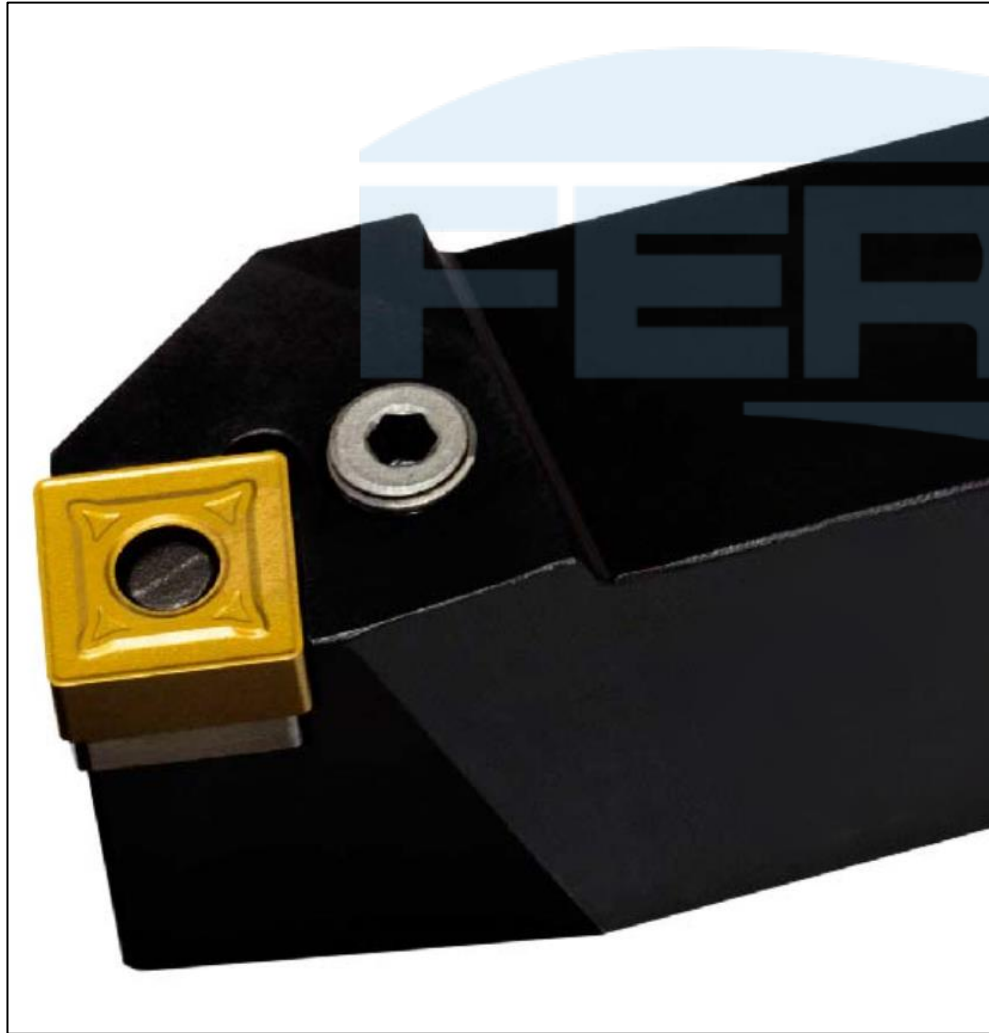

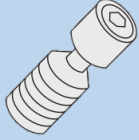
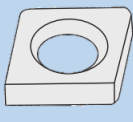
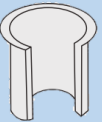
Ilustração na versão direita

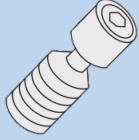
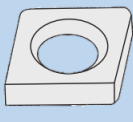
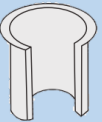
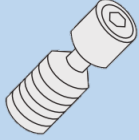
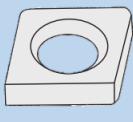
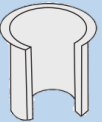
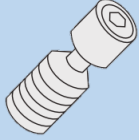
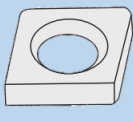
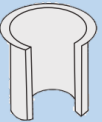
Produtos	Dimensões (mm)				Pastilha	Acessórios				
	h	b	l	f			 Alavanca	 Parafuso	 Calço	 Rebite
PCBNR/L 2020 K12	20	20	125	20	CN_1204					
PCBNR/L 2525 M12	25	25	150	25						
PCBNR/L 3225 P12	32	25	170	32						
PCBNR/L 2525 M16	25	25	150	25	CN_1606					
PCBNR/L 3232 P16	32	32	170	32						
PCBNR/L 3232 P19	32	32	170	32	CN_1906					
PCBNR/L 4040 S19	40	40	250	40						