

SISTEMA DE FIXAÇÃO POR ALAVANCA

PTTNR

Suporte para torneiar 60° com pastilha negativa triangular











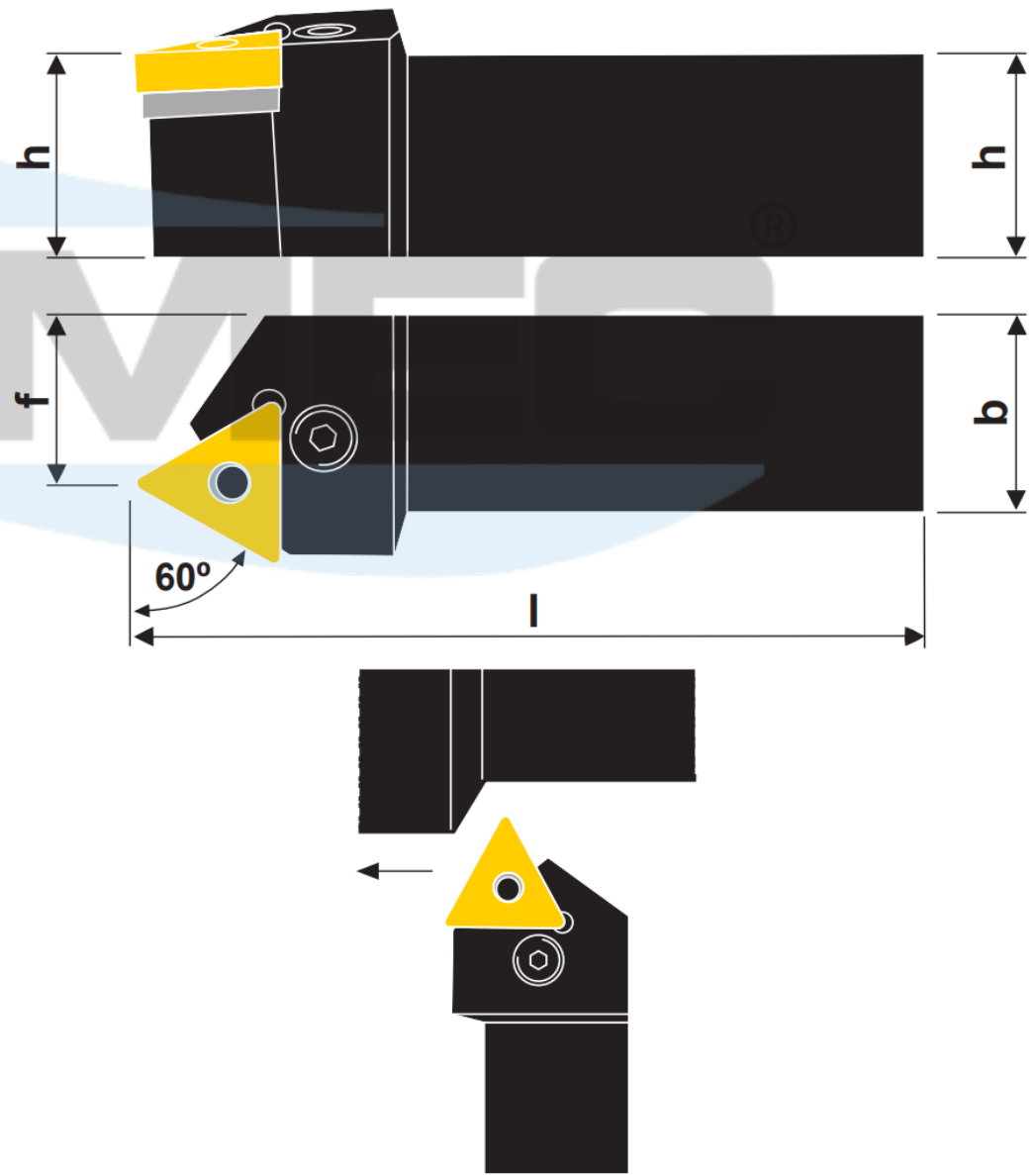

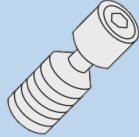
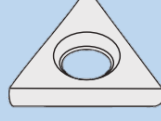
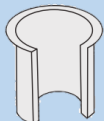
Ilustração na versão direita

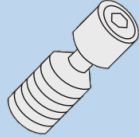
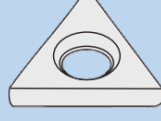
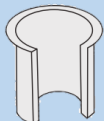
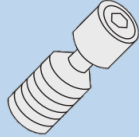
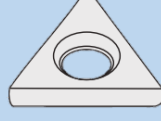
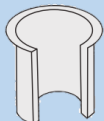
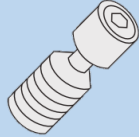
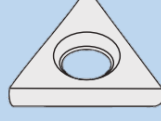
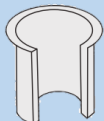
Produtos	Dimensões (mm)				Pastilha	Acessórios									
	h	b	l	f			 Alavanca	 Parafuso	 Calço	 Rebite	 Chave Allen				
PTTNR/L 1212 F11	12	12	80	11	TN_1103										
PTTNR/L 1616 H11	16	16	100	13							174.3-846-1	174.3-829	-	-	C - 5/64
PTTNR/L 1616 H16	16	16	100	13	TN_1604										
PTTNR/L 2020 K16	20	20	125	17							174.3-840M	174.3-820M	179.3-850M	174.3-860	C - 2,5
PTTNR/L 2525 M16	25	25	150	22							174.3-841M	174.3-821	179.3-852M	174.3-861	C - 3,0
PTTNR/L 3225 P16	32	25	170	22	TN_2204										
PTTNR/L 2525 M22	25	25	150	22							174.3-841M	174.3-821	179.3-852M	174.3-861	C - 3,0
PTTNR/L 3225 P22	32	25	170	22											