

SISTEMA DE FIXAÇÃO DUPLO POR PINO E GRAMPO

MCKNR

Suporte para facear 75° com pastilha negativa 80° para aproveitamento do ângulo de 100°

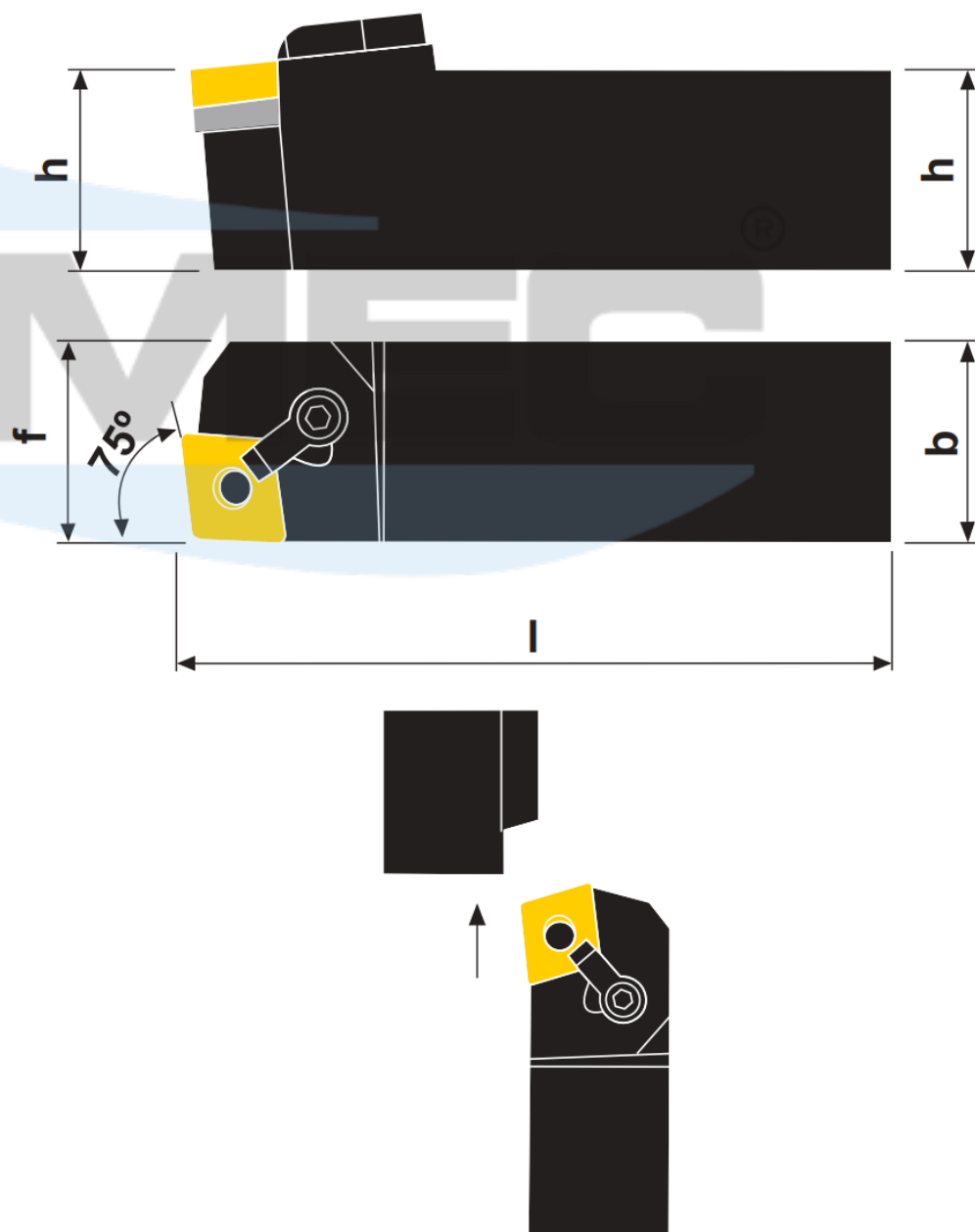

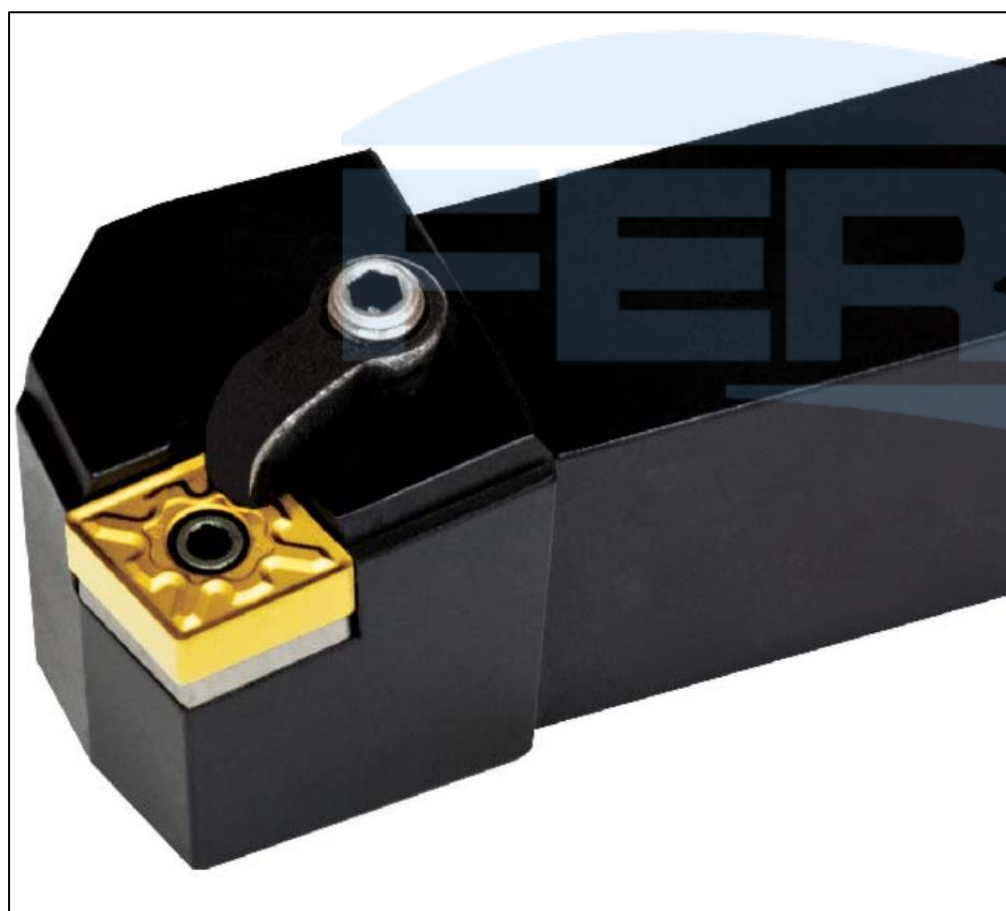
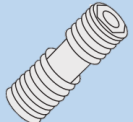

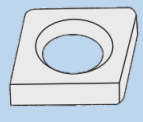
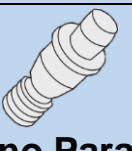
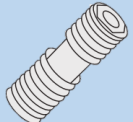
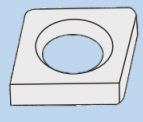
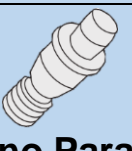

Ilustração na versão direita

Produtos	Dimensões (mm)				Pastilha	Acessórios				
	h	b	l	f			 Grampo	 Parafuso	 Calço	 Pino Paraf. do Calço
MCKNR/L 2020 K12	20	20	125	17	CN_1204 CNGN_1204 CNGN_1203	 HL1813	 MC1204	 CTM617	 ML0625	M - 2,5 M - 3,0
MCKNR/L 2525 M12	25	25	150	22						
MCKNR/L 3225 P12	32	25	170	22						
MCKNR/L 2525 M16	25	25	150	22	CN_1606 CNGN1606	NC-9 NC-12	HT-2	SCN-53	NL-58 PS-58	C - 1/8 C - 4,0
MCKNR/L 3225 P16	32	25	170	27						
MCKNR/L 3232 P19	32	32	170	27	CN_1906 CNGN1906	HL2217	MC1904	CTM1022	ML0830	M - 4,0
MCKNR/L 4040 S19	40	40	250	35						