

# SISTEMA DE FIXAÇÃO DUPLO POR PINO E GRAMPO

## MSDNN

Suporte neutro para torneiar 45° com pastilha negativa quadrada







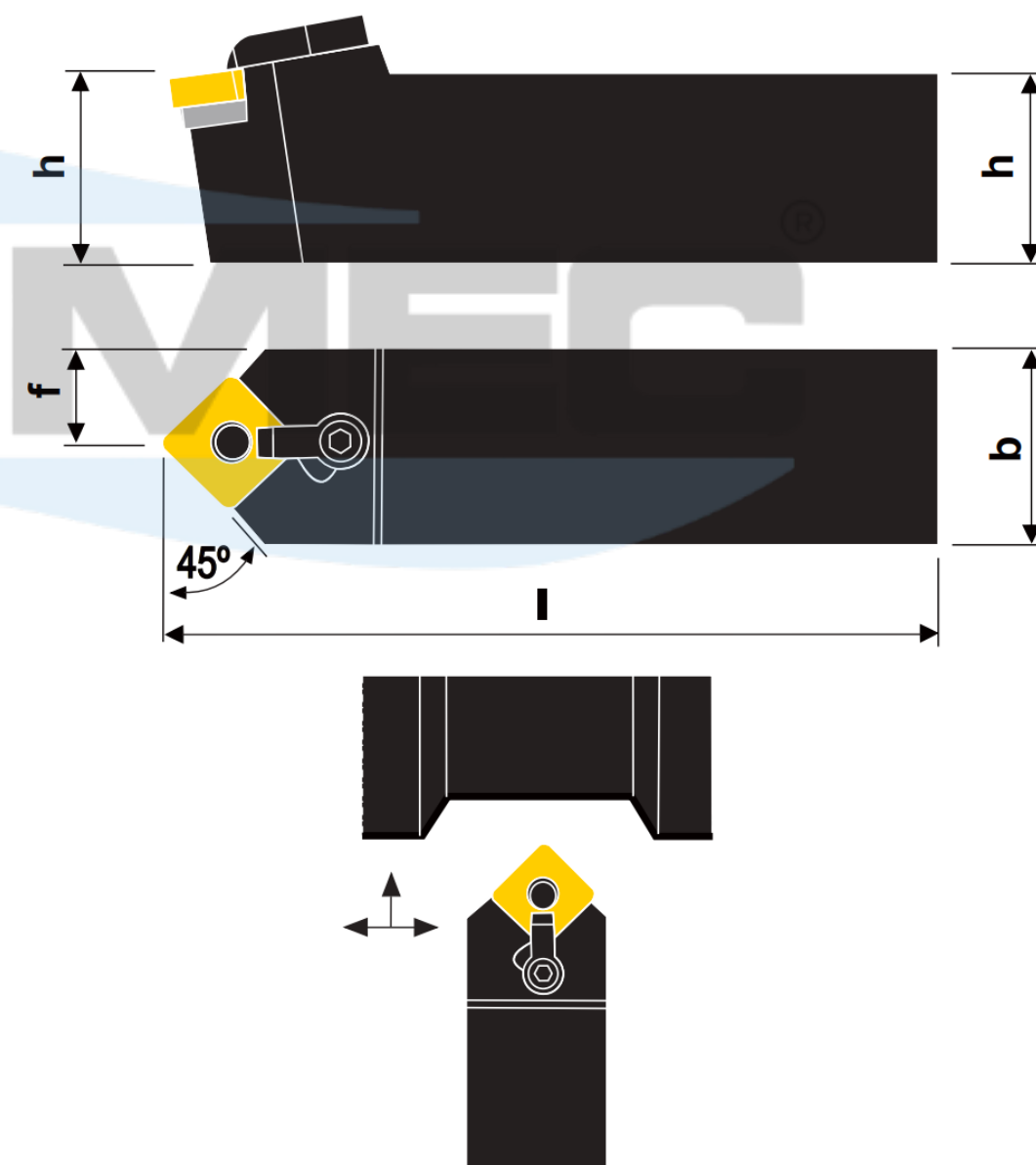
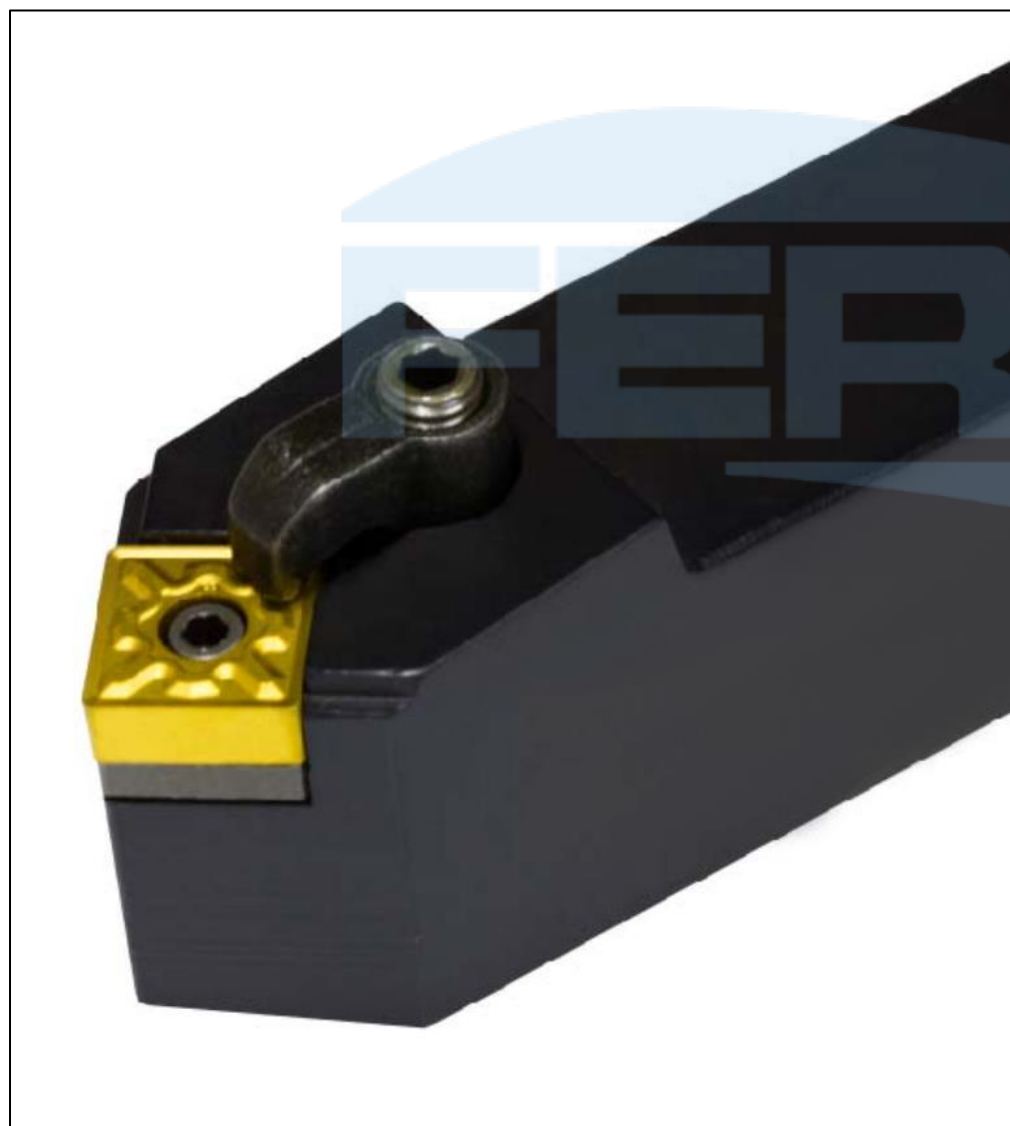
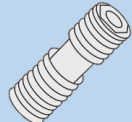
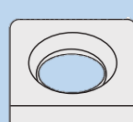
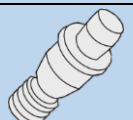
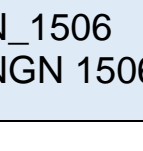
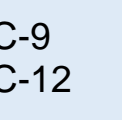
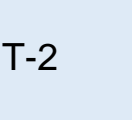
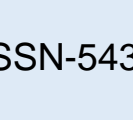
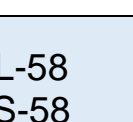
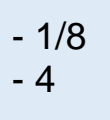
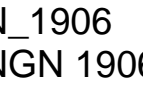
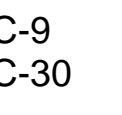
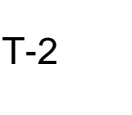
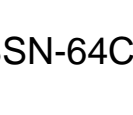
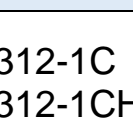

Ilustração na versão direita

Produtos	Dimensões (mm)				Pastilha	Acessórios				
	h	b	l	f		Grampo	Parafuso	Calço	Pino Paraf. do Calço	Chave Allen
MSDNN 2020 K12	20	20	125	125	 SN_1204 SNGN 1204 SNGN 1204	 NC-20 NC-23	 HT-1	 ISSN-423 ISSN-433	 NL-46 PS-46	 C - 3/32 C - 1/8
MSDNN 2525 M12	25	25	150	150						
MSDNN 3225 P12	32	25	170	170						
MSDNN 3232 P15	32	32	170	170	 SN_1506 SNGN 1506	 NC-9 NC-12	 HT-2	 ISSN-543	 NL-58 PS-58	 C - 1/8 C - 4
MSDNN 4040 S15	40	40	250	250						
MSDNN 3232 P19	32	32	170	170	 SN_1906 SNGN 1906	 NC-9 NC-30	 HT-2	 SSN-64C	 H312-1C H312-1CH	 C - 4
MSDNN 4040 S19	40	40	250	250						