

# SISTEMA DE FIXAÇÃO POR CUNHA-GRAMPO

## MWLNR

Suporte para tornear 95° com pastilha trigonal negativa 80°









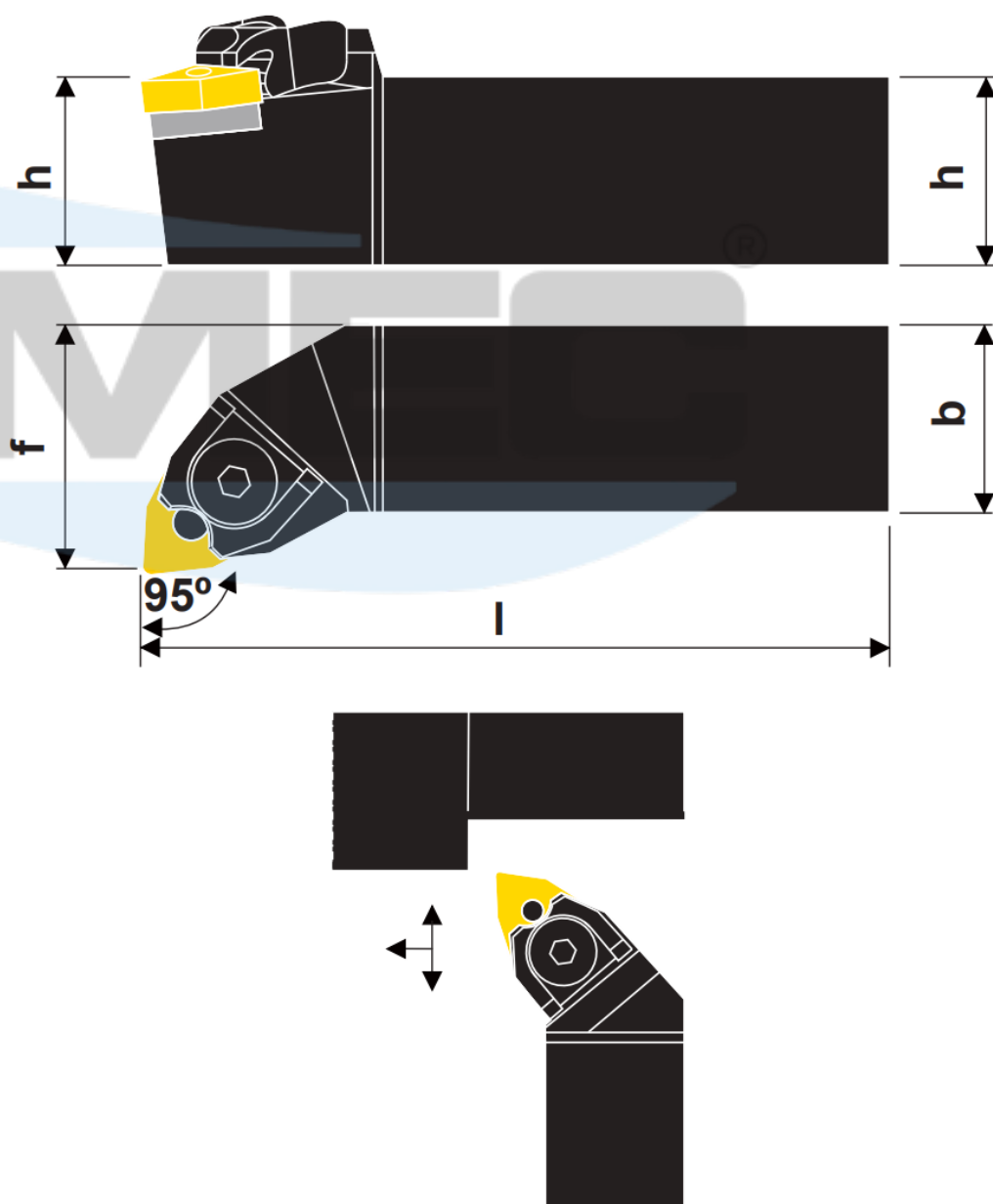

Ilustração na versão direita

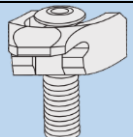
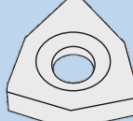
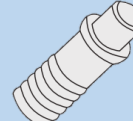
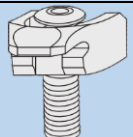
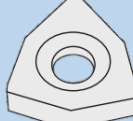
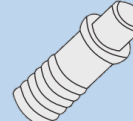
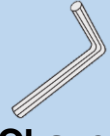
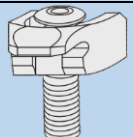
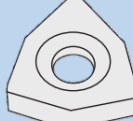
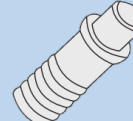
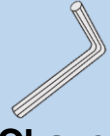
Produtos	Dimensões (mm)				Pastilha	Acessórios				
	h	b	l	f						
MWLNR/L 1616 H06	16	16	100	21	WN_0604					
MWLNR/L 2020 K06	20	20	125	25						
MWLNR/L 2525 M06	25	25	150	32						
MWLNR/L 2020 K08	20	20	125	25	WN_0804					
MWLNR/L 2525 M08	25	25	150	32						
MWLNR/L 3232 P08	32	32	170	40						
MWLNR/L 4040 S08	40	40	250	50						