

SISTEMA DE FIXAÇÃO POR PARAFUSO TORX

SDACR

Suporte para torneiar e facear 90° com pastilha positiva 55°

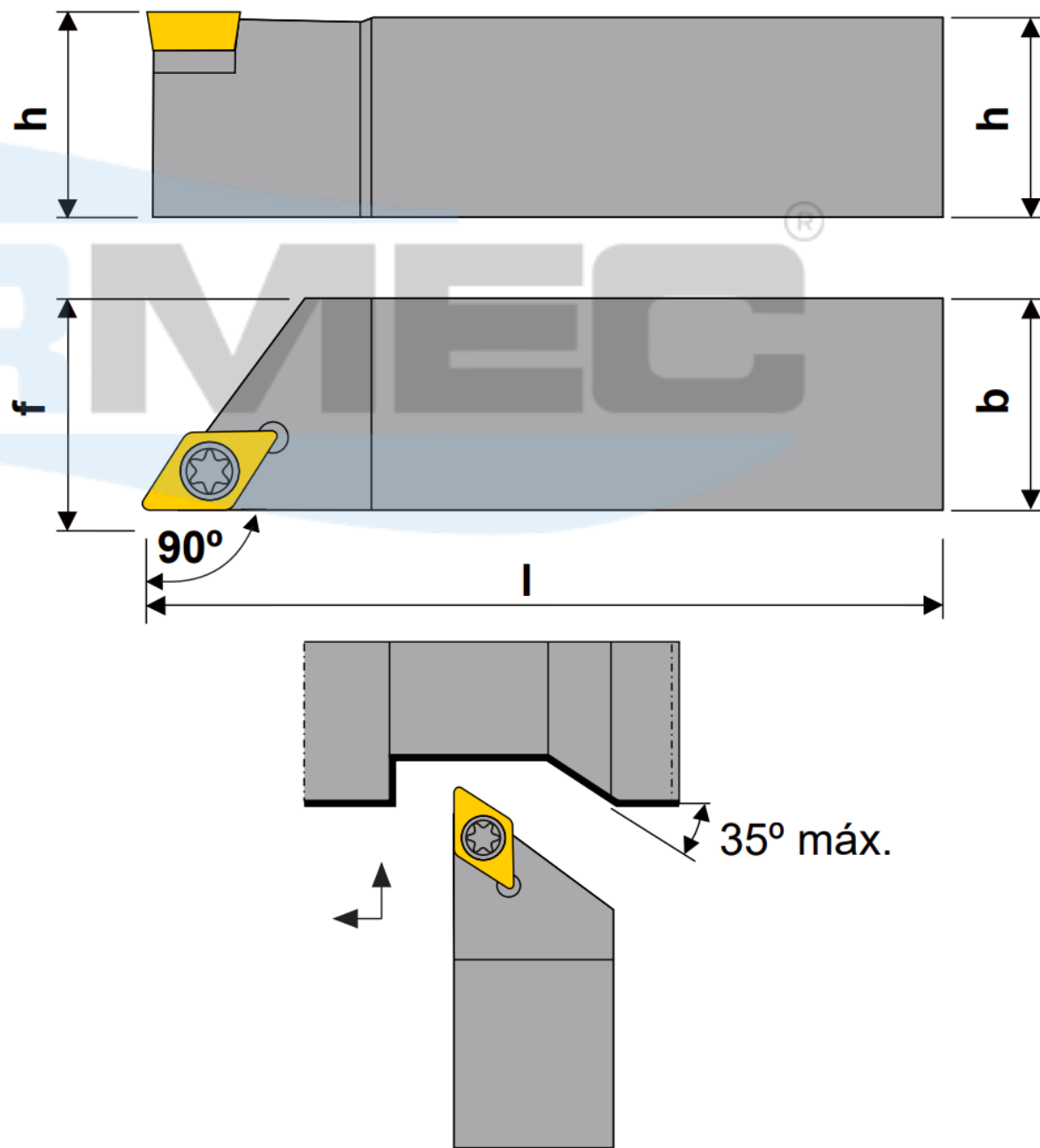

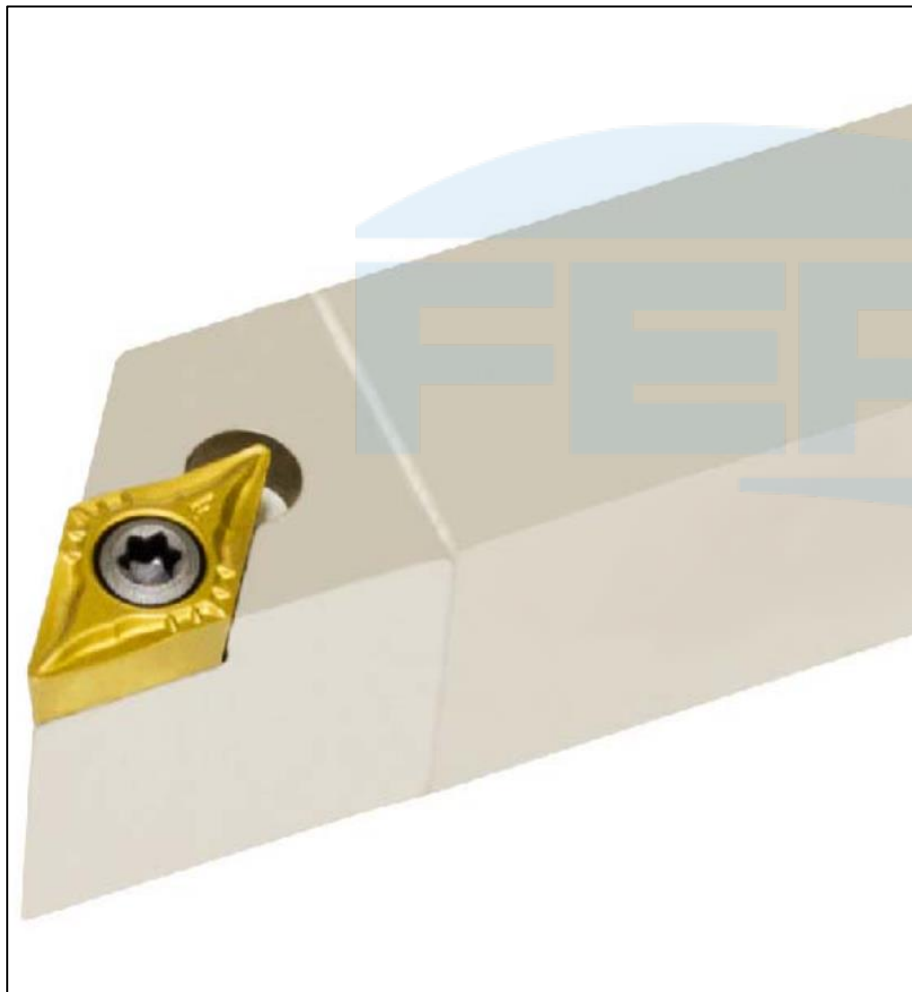
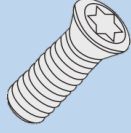

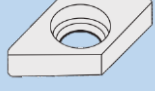
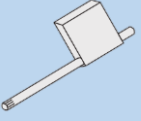

Ilustração na versão direita

Produtos	Dimensões (mm)				Pastilha 	Acessórios			
	h	b	l	f		 Parafuso Torx	 Calço	 Parafuso do Calço	 Chave Torx
SDACR/L 1010 M07	10	10	150	10	DC_0702	5513 020-03	-	-	T7-B
SDACR/L 1212 M07	12	12	150	12		5513 020-10	-	-	T15-B
SDACR/L 1212 M11	12	12	150	12	DC_11T3	5513 020-01	5322 263-01	5512 090-01	T15-B
SDACR/L 1616 M11	16	16	150	16					C - 9/64
SDACR/L 2020 M11	20	20	150	20					