

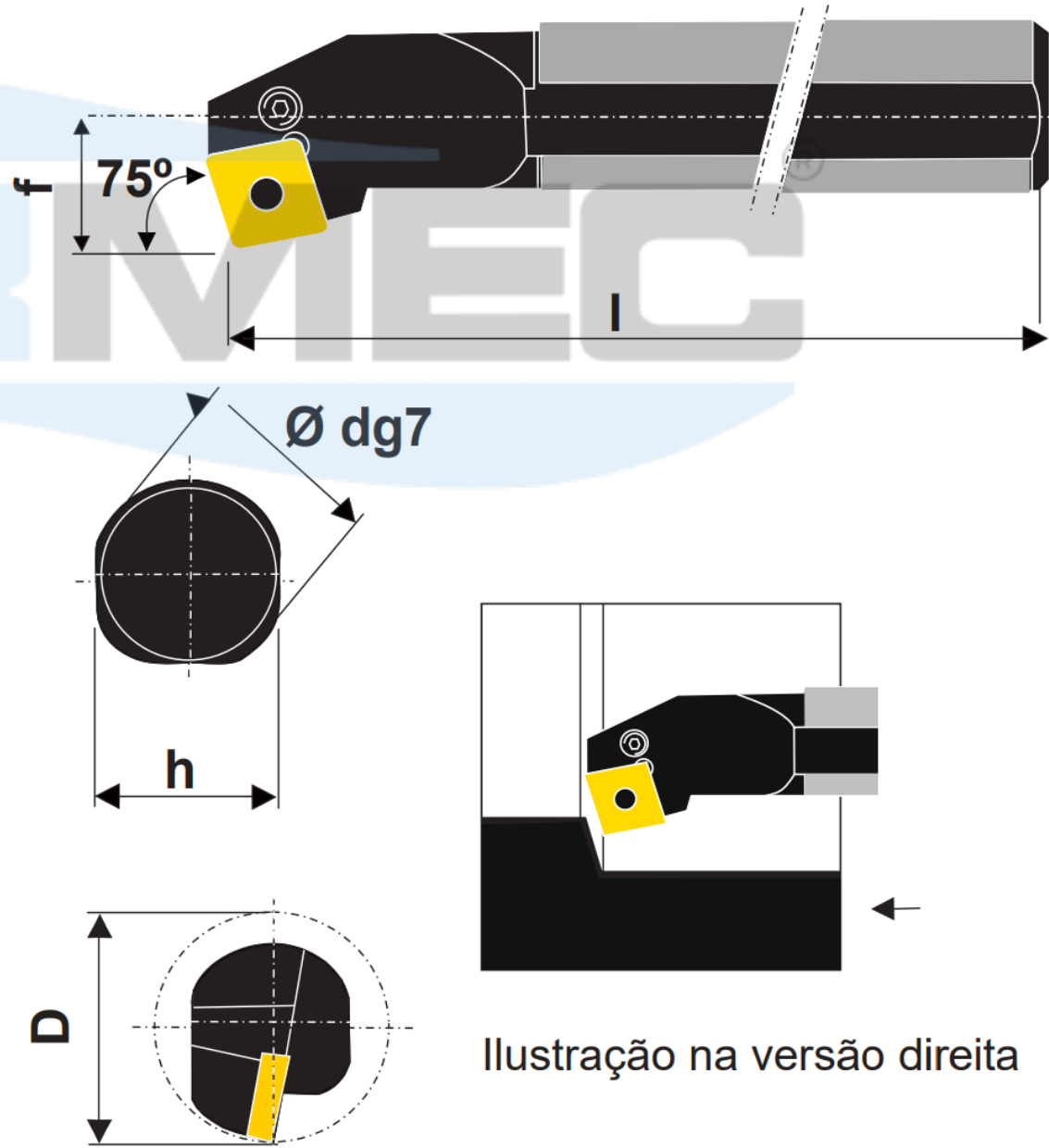

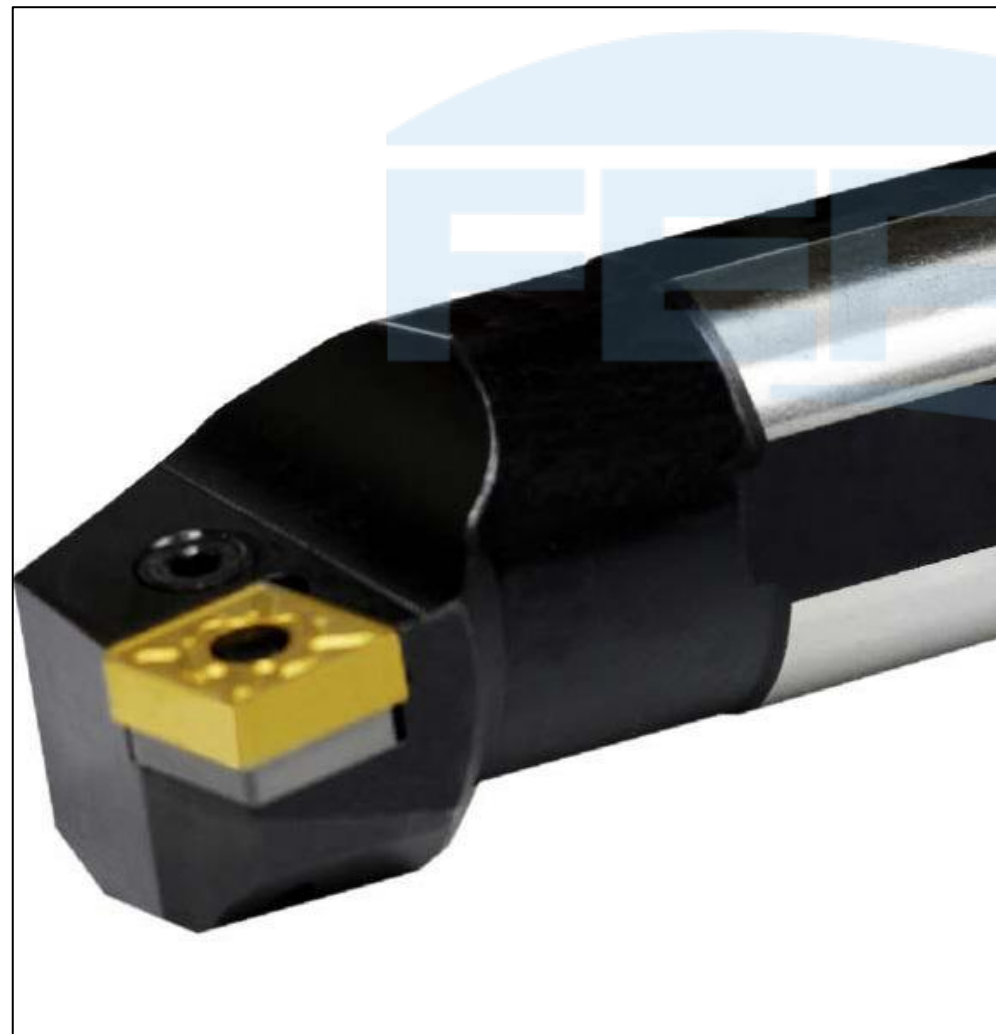



SISTEMA DE FIXAÇÃO POR ALAVANCA

PCKNR

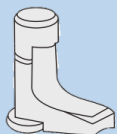
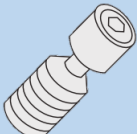
Suporte interno 75° com pastilha negativa 80° para utilizar ângulo de 100°

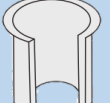

Produtos	Dimensões (mm)					Pastilha	Acessórios					
	d	h	l	f	D		Alavanca	Parafuso	Calço	Rebite	Chave Allen	
S25T PCKNR/L 12	25	23	300	17	32	 100°						
S32U PCKNR/L 12	32	30	350	22	40		CN_1204	174.8-841-1	174.8-832M	-	-	C - 2,5
S40V PCKNR/L 12	40	37	400	27	50		174.3-841M	174.3-858	171.31-850M	174.3-861	C - 3	
S40V PCKNR/L 19	40	37	400	27	50	CN_1906	174.3-848-M	174.3-821	171.31-850M	174.3-861	C - 3	
S50W PCKNR/L 19	50	47	450	35	63		174.3-849M	174.3-822M	171.31-851M	174.3-868	C - 4	