

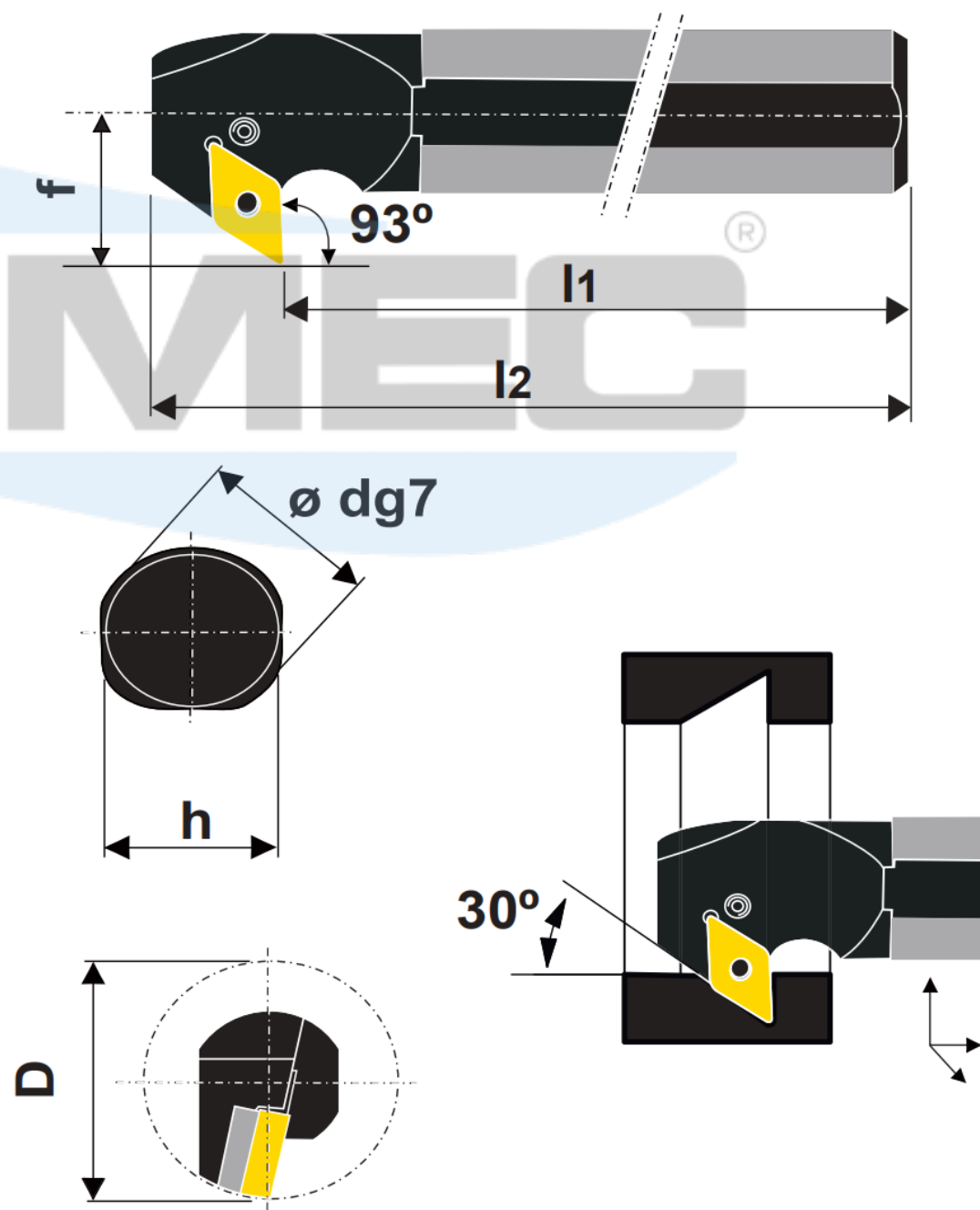

SISTEMA DE FIXAÇÃO POR ALAVANCA

PDZNR

Suporte interno 93° com pastilha negativa 55°

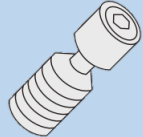
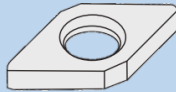
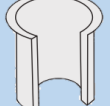
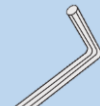

Produtos	Dimensões (mm)						Pastilha	Acessórios				
	d	h	l	l2	f	D		 Alavanca	 Parafuso	 Calço	 Rebite	 Chave Allen
S25T PDZNR/L 11	25	23	300	320	22	40	DN_1104	5432 015-021	438.3-830	-	-	C-5/64
S32T PDZNR/L 15	32	30	350	375	25	25	DN_1506	174.3-847M	174.3-830M	171.35-851M	174.3-861	C - 3
S40V PDZNR/L 15	40	37	400	425	29	50						