

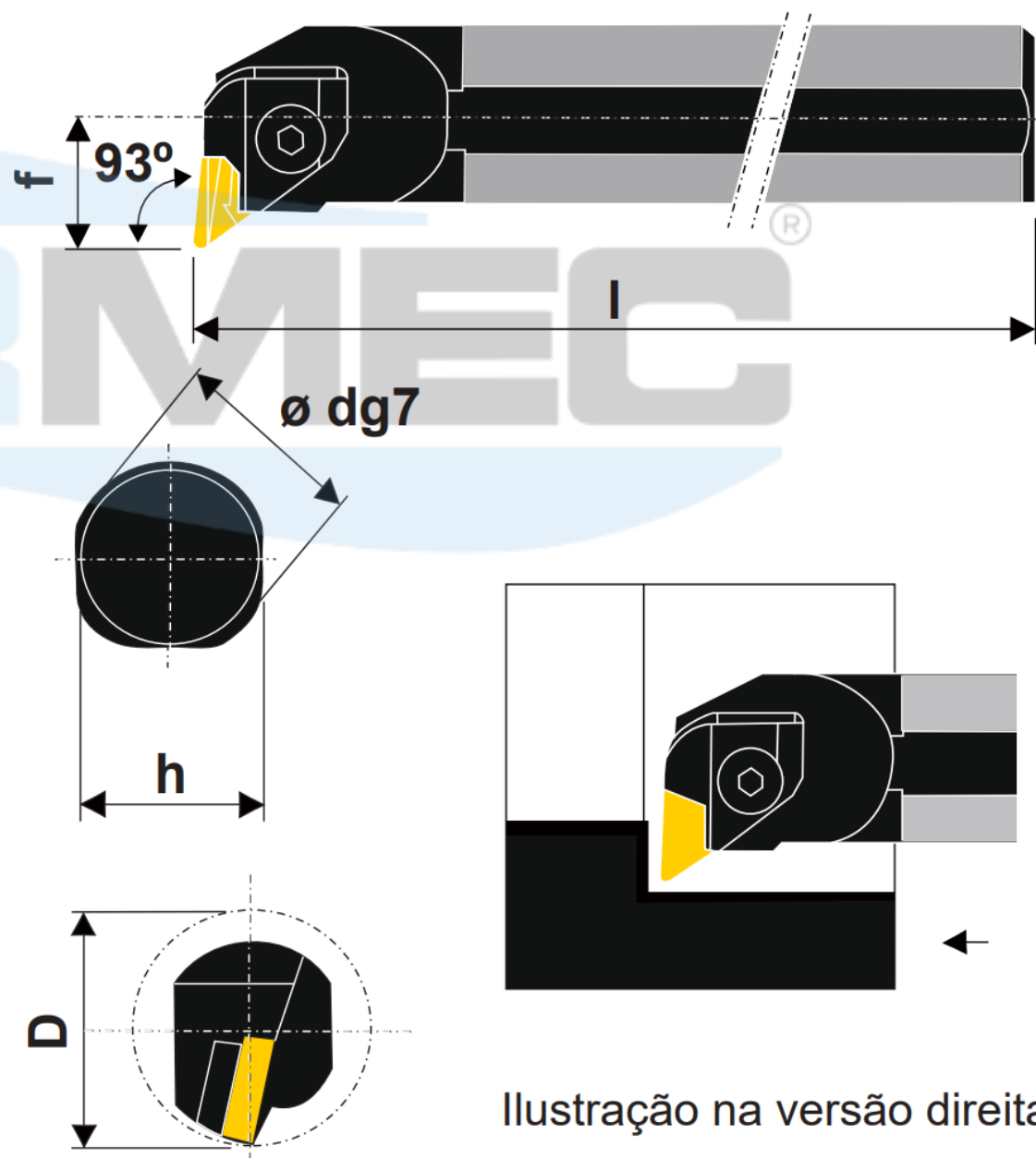

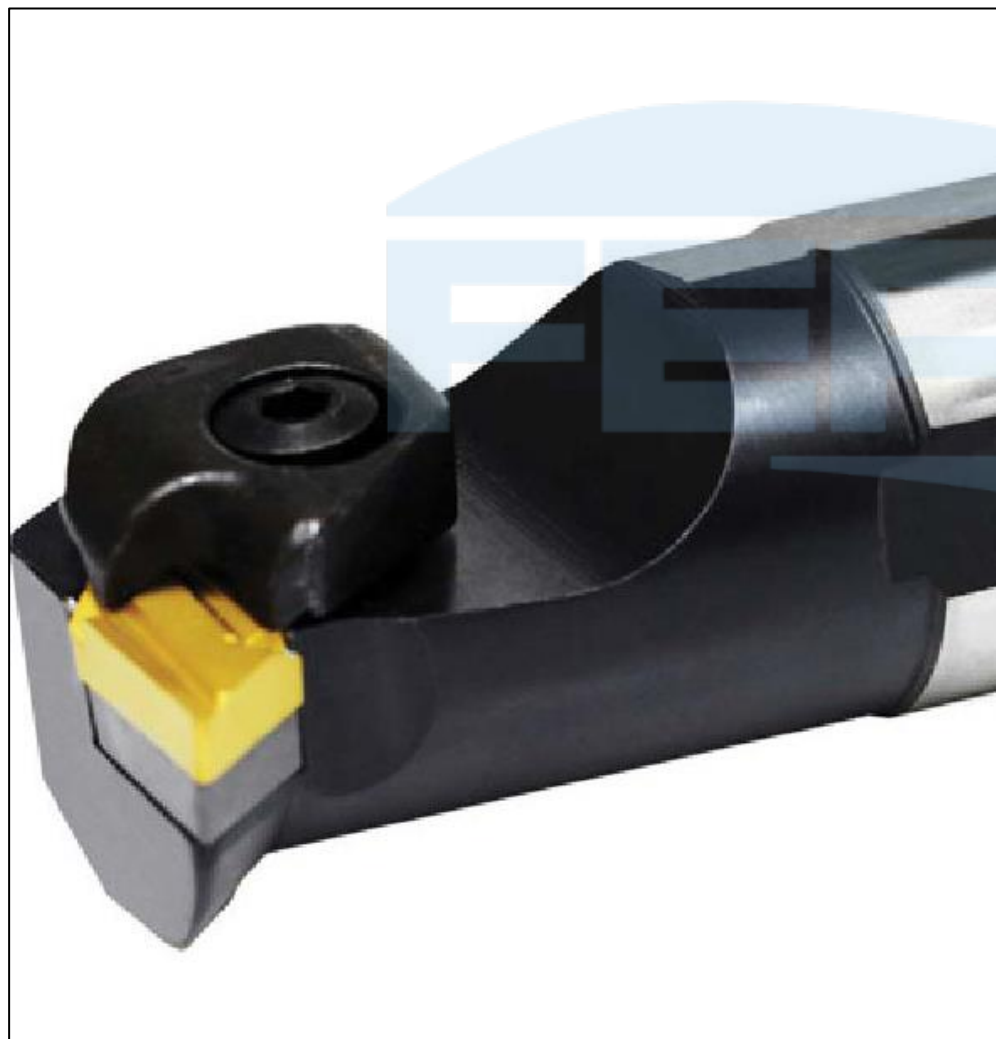

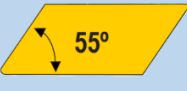



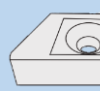

SISTEMA DE FIXAÇÃO POR GRAMPO

CKUNR

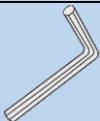
Suporte interno 93° com pastilha positiva 55°



Produtos	Dimensões (mm)					Pastilha 	Acessórios										
	d	h	l	f	D		 Grampo	 Paraf. do Grampo	 Mola	 Pino c/ mola	 Calço	 Rebite	 Chave Allen				
S25T CKUNR/L 16	25	23	300	17	32	KNUX 1604					-	-	C - 4				
S32U CKUNR/L 16	32	30	350	22	40						170.5-824 170.5-825	170.5-865		170.5-848	471.5-821	170.5-581R 170.5-851L	174.1-866
S40V CKUNR/L 16	40	37	400	27	50												
S50W CKUNR/L 16	50	47	450	35	63												