

SISTEMA DE FIXAÇÃO DUPLA POR PINO E GRAMPO

MCKNR

Suporte interno 75° com pastilha negativa 80° para utilizar ângulo de 100°

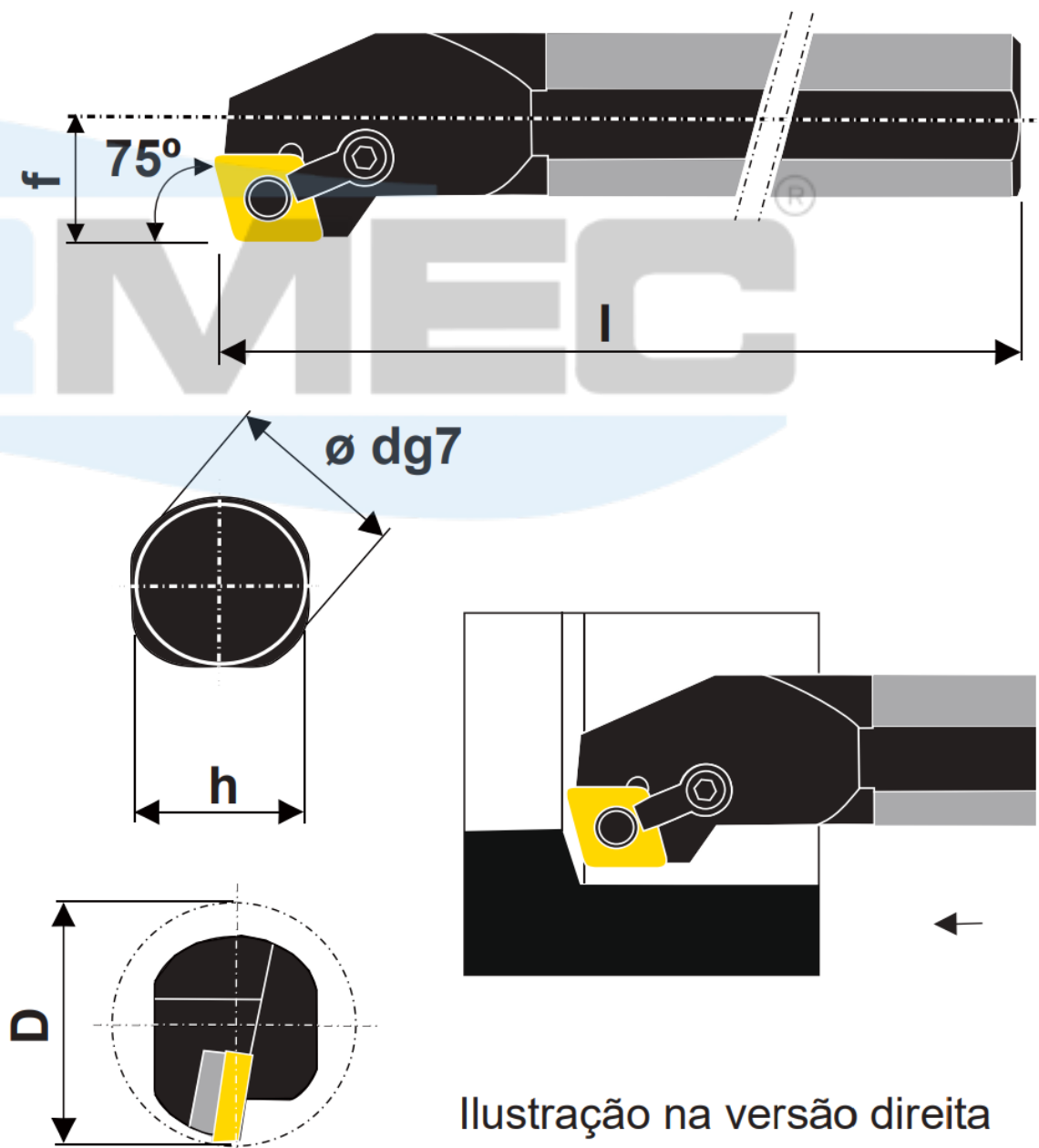

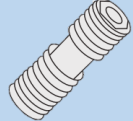

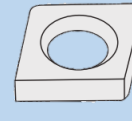
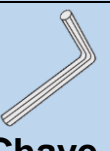

Ilustração na versão direita

Produtos	Dimensões (mm)					Pastilha	Acessórios				
	d	h	l	f	D		Grampo	Parafuso	Calço	Pino Paraf. do Calço	Chave Allen
S25T MCKNR/L 12	25	23	300	17	32	 CN_1204	 NC - 20 NC - 22	 HT-1	 SCN-43	 H308-1D H308-1C	 C - 2,5 C - 1/8
S32U MCKNR/L 12	32	30	350	22	40						
S40V MCKNR/L 12	40	37	400	27	50						
S50W MCKNR/L 12	50	47	450	35	63						