

# SISTEMA DE FIXAÇÃO RÍGIDA

## DCKNR

Suporte interno 75° com pastilha negativa 80° para aproveitamento de 100°











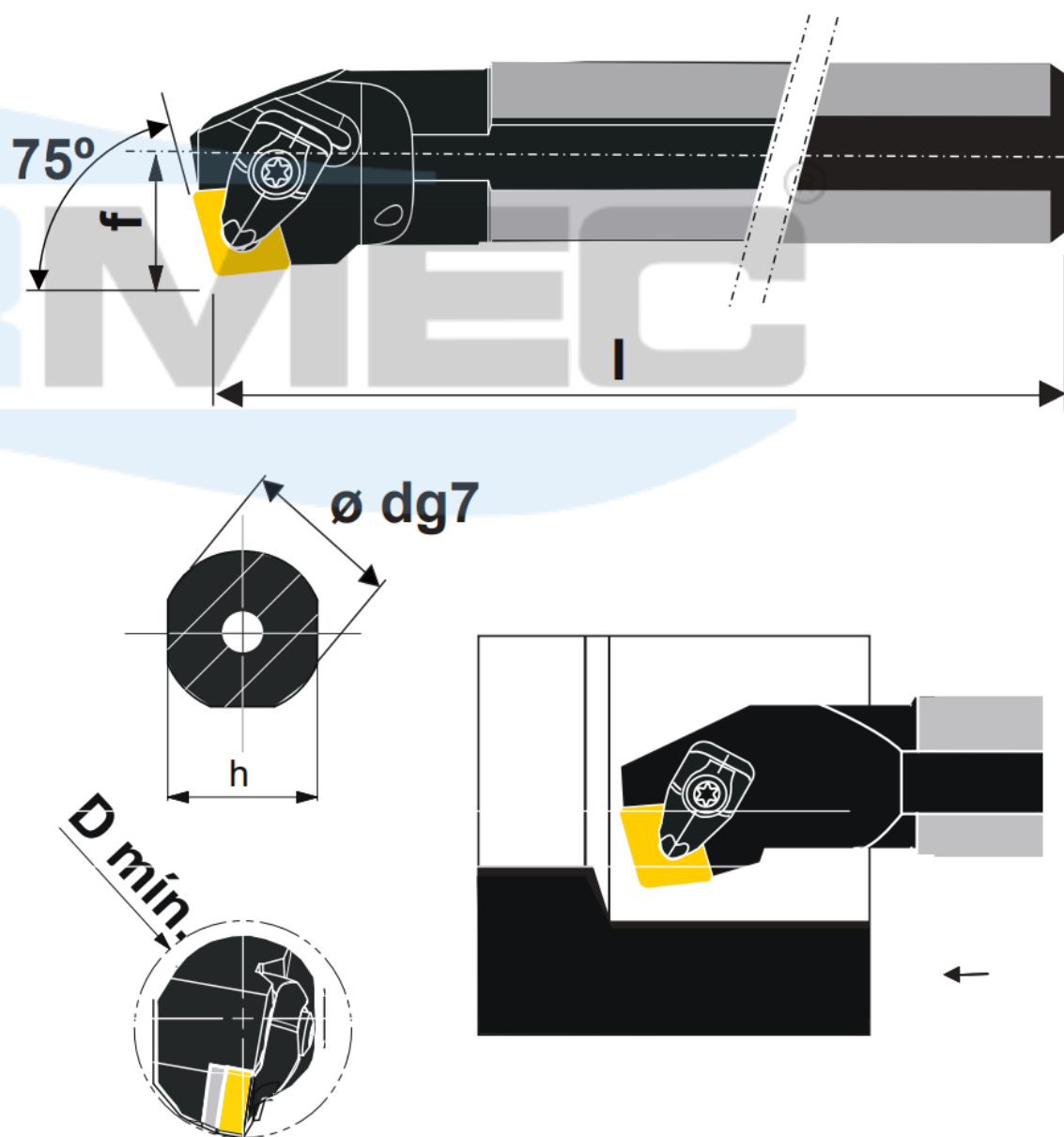



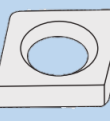

Ilustração na versão direita

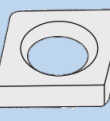
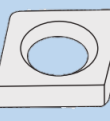
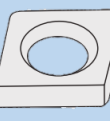
Produtos	Dimensões (mm)					Pastilha	Acessórios						
	d	h	l	f	D		Paraf. do Grampo	Grampo	Mola	Pino	Calço	Paraf. do Calço	Chave Torx
A25T DCKNR/L 12	25	23	300	17	32	 80°	 5412 086-02	 5412 028-02	 5412 001-58	 5412 030-307	 5322 236-03	 5513 020-02	 T15 - F
A32T DCKNR/L 12	32	30	300	22	40						 5322 234-01		
A40T DCKNR/L 12	40	37	300	27	50						 5322 236-01		
A50U DCKNR/L 19	50	47	350	35	63	 5412 086-03	 5412 028-04	 5412 001-59	-	 5322 236-01	 5513 020-07	 T20 - F	