

SISTEMA DE FIXAÇÃO POR PARAFUSO-TORX

DRSNR

Suporte interno com pastilha negativa redonda









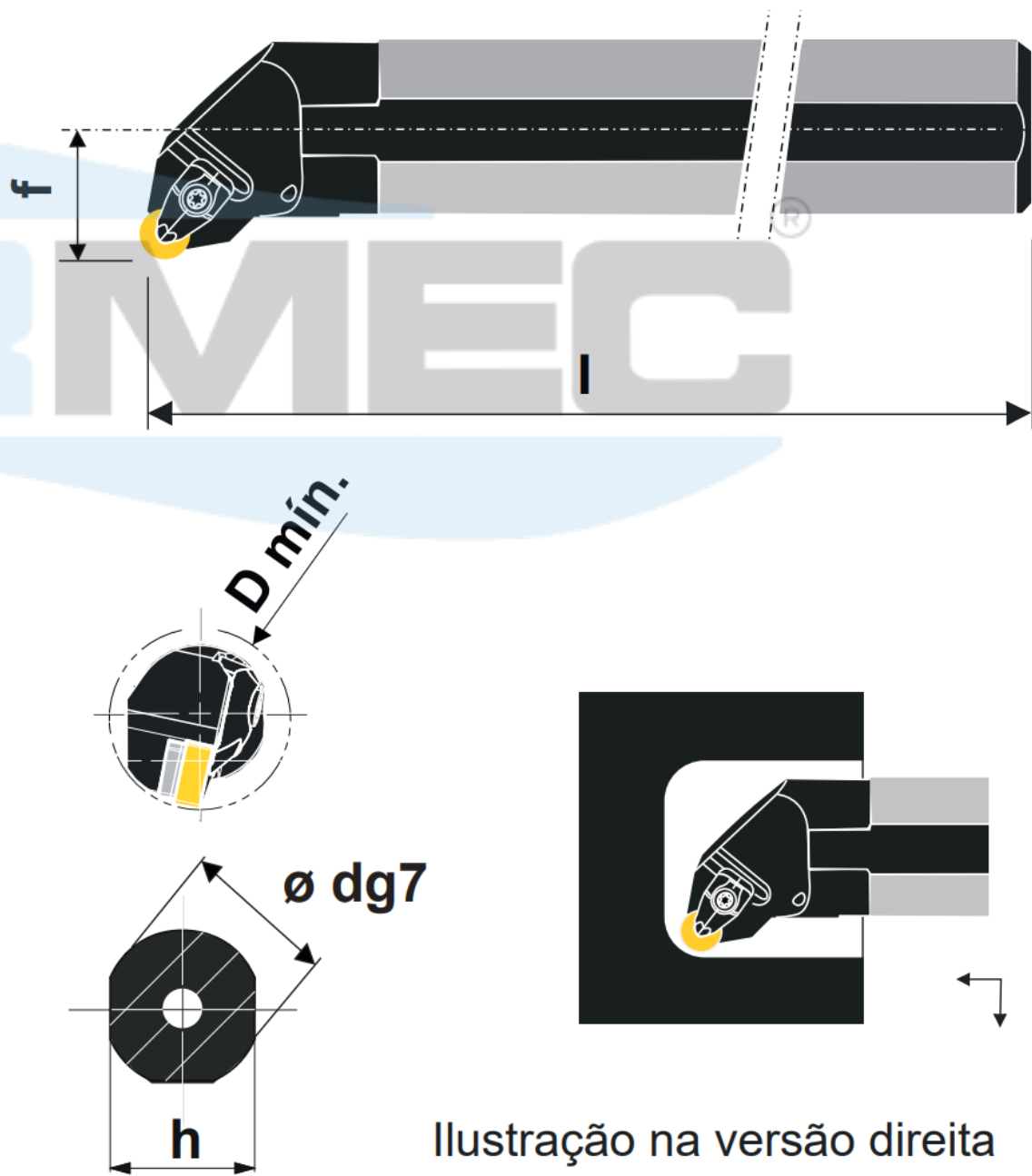

Ilustração na versão direita

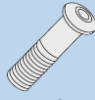
Produtos	Dimensões (mm)					Pastilha	Acessórios						
	d	h	l	f	D		 Paraf. do Grampo	 Grampo	 Mola	 Pino	 Calço	 Paraf. do Calço	 Chave Torx
A25T DRSNR/L 09	25	23	300	17	32	RN_0903	5412 086-01	5412 028-01	5412 001-57	5412 030-255	5322 156-01	5513 020-04	T9-F
A32T DRSNR/L 09	32	30	300	22	40								
A40T DRSNR/L 09	40	37	300	27	50								
A50U DRSNR/L 09	50	47	350	35	63								
A25T DRSNR/L 12	25	23	300	17	32	RN_1204	5412 086-02	5412 028-02	5412 001-58	5412 030-307	5322 155-02	5513 020-02	T15-F
A32T DRSNR/L 12	32	30	300	22	40								
A40T DRSNR/L 12	40	37	300	27	50								
A50U DRSNR/L 12	50	47	350	35	63								