

# SISTEMA DE FIXAÇÃO POR PARAFUSO TORX

## SWUBR

Suporte interno 93° com pastilha trigonal 80°

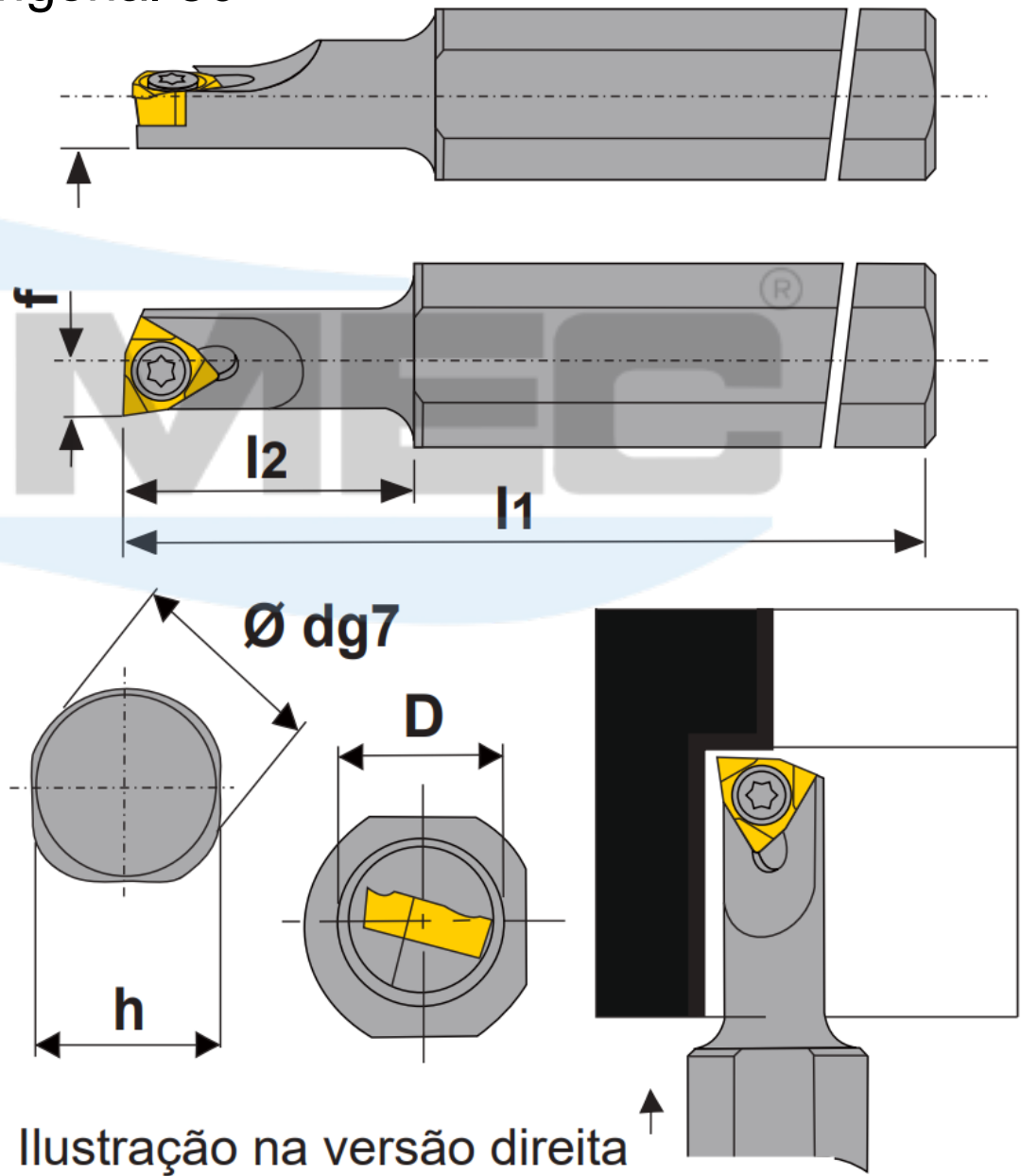
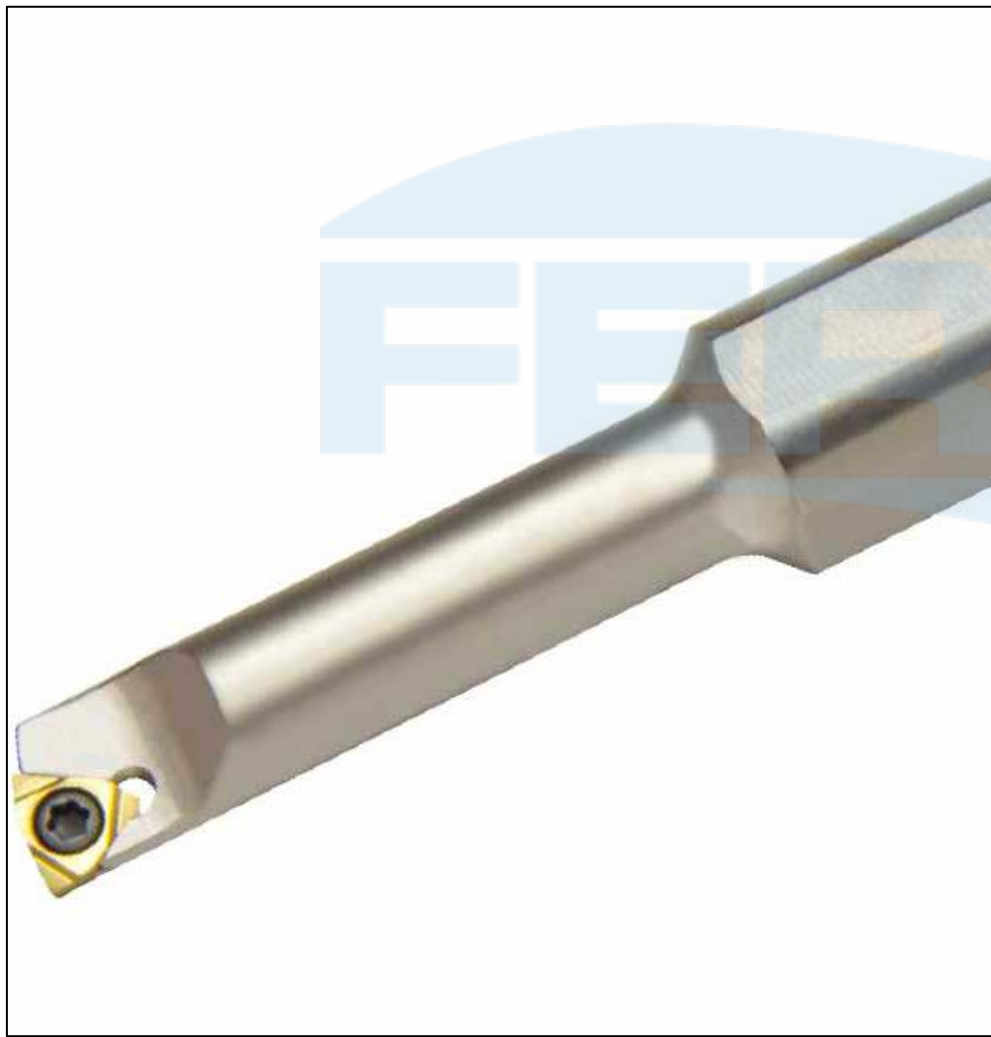
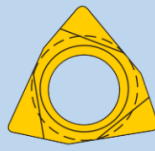
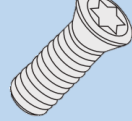
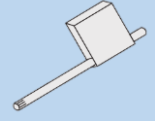
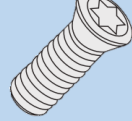
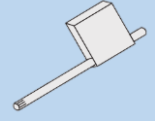

Produtos	Dimensões (mm)						Pastilha	Acessórios	
	d	h	l1	l2	f	D		 Parafuso Torx	 Chave Torx
C08K SWUBR/L 06 HP	8	7	125	-	4,3	8,5	WB_0601	 5513 020-27	 T6 - B
C10Q SWUBR/L 06 HP	10	9	180	-	6	12			
S0606H SWUBR/L 06 HP	6	5	100	-	3,3	6			
S0610H SWUBR/L 06 HP	10	9	100	20	3	6			
S0710H SWUBR/L 06 HP	10	9	100	24	3,5	7			
S0808J SWUBR/L 06 HP	8	8	110	-	4,3	8,5			
S0812J SWUBR/L 06 HP	12	11	110	32	4	8			
S1012M SWUBR/L 06 HP	12	11	150	32	5	10			